

4" Submersible Pump

Solid of its 40 years of experience, Pompcos is proud to present its new submersible pumps of the FLS and FLT series.

Designed, developed and manufactured by a team of experts who have been able to anticipate and meet all your possible needs in terms of submersible pumps.

Its main features are:

- *Higher efficiency than equivalent pumps on the market;
- *Increased resistance to the wear of time;

The new submersible pump of the FLS series is synonymous with efficiency, durability, reliability and performance. In other words, they are synonymous with Pompcos.

NEW
Better Efficiency
New Design



Motor by:



Other motors optional. Consult factory.

Part	FLS Series Stainless steel
Check valve	External check valve made of stainless steel.
Discharge head & Motor bracket	Made of (304) stainless steel.
Shaft	Hexagonal shaft made of (303) stainless steel for corrosion and wear resistance
Couplings	Made of stainless steel and fit perfectly to any 4" standard motor which allows maximum efficiency.
Diffuser *	Injection molded in engineering composite.
Washer	Made of stainless steel, they prevent wearing of the impellers and diffusers.
Impeller *	Injection molded in Acetal. (Four colors for a better identification)
Disc*	Made of stainless steel.
Top bearing	Injection molded in Polypropylene plus fibers, with a rubber centre for an even more precise alignment of the shaft. The rubber center considerably reduces wearing of the shaft caused by sand.
Screen	Made of stainless steel, it prevents the impellers from large debris obstructions.
Cable guard	Made of stainless steel, corrosion resistant, protects motor lead.
Housing	Made of (T-304) stainless steel, it is threaded for easy maintenance.
Fasteners	All stainless steel fasteners.

* Designed to resist wear in abrasive waters.



On 1/2, 3/4 & 1 HP pumps & motors



FLS

4" submersible pump Stainless steel FLS series 6-10-15-25

3 WIRES + GROUND					(Control box included only with 3 wires motors)		
H.P.	G.P.M.	Stages	Ph.	Volts	Part number	Model	Suggested list price
1/2	6	11	1	115	438-0020	FLS6-50-113P	1 376,00 \$
	6	11	1	230	438-0040	FLS6-50-233P	1 376,00 \$*
	10	9	1	115	438-0220	FLS10-50-113P	1 158,00 \$
	10	9	1	230	438-0240	FLS10-50-233P	1 116,00 \$*
	15	6	1	115	438-0420	FLS15-50-113P	1 201,00 \$
	15	6	1	230	438-0440	FLS15-50-233P	1 201,00 \$
3/4	6	15	1	230	438-1040	FLS6-75-233P	1 653,00 \$*
	10	12	1	230	438-1240	FLS10-75-233P	1 376,00 \$*
	15	7	1	230	438-1440	FLS15-75-233P	1 434,00 \$
	25	5	1	230	438-1640	FLS25-75-233P	1 415,00 \$
1	6	18	1	230	438-2040	FLS6-100-233P	1 790,00 \$
	10	14	1	230	438-2240	FLS10-100-233P	1 514,00 \$*
	15	9	1	230	438-2440	FLS15-100-233P	1 558,00 \$
	25	6	1	230	438-2640	FLS25-100-233P	1 509,00 \$
1 1/2	6	23	1	230	438-3040	FLS6-150-233P	2 245,00 \$
	6	23	3	575	438-3070	FLS6-150-575P	2 033,00 \$
	10	19	1	230	438-3240	FLS10-150-233P	2 108,00 \$
	10	19	3	575	438-3270	FLS10-150-575P	1 865,00 \$
	15	12	1	230	438-3440	FLS15-150-233P	2 001,00 \$
	15	12	3	575	438-3470	FLS15-150-575P	1 752,00 \$
	25	8	1	230	438-3640	FLS25-150-233P	1 940,00 \$
	25	8	3	575	438-3670	FLS25-150-575P	1 689,00 \$
2	10	23	1	230	438-4240	FLS10-200-233P	2 926,00 \$
	10	23	3	575	438-4270	FLS10-200-575P	2 122,00 \$
	15	15	1	230	438-4440	FLS15-200-233P	2 702,00 \$
	15	15	3	575	438-4470	FLS15-200-575P	1 995,00 \$
	25	10	1	230	438-4640	FLS25-200-233P	2 653,00 \$
	25	10	3	575	438-4670	FLS25-200-575P	1 940,00 \$
3	10	31	1	230	438-5240	FLS10-300-233P	4 077,00 \$
	10	31	3	575	438-5270	FLS10-300-575P	2 952,00 \$
	15	20	1	230	438-5440	FLS15-300-233P	3 952,00 \$
	15	20	3	575	438-5470	FLS15-300-575P	2 814,00 \$
	25	14	1	230	438-5640	FLS25-300-233P	3 751,00 \$
	25	14	3	575	438-5670	FLS25-300-575P	2 653,00 \$
5	15	32	1	230	438-6440	FLS15-500-233P	5 339,00 \$
	15	32	3	575	438-6470	FLS15-500-575P	4 139,00 \$
	25	21	1	230	438-6640	FLS25-500-233P	5 164,00 \$
	25	21	3	575	438-6670	FLS25-500-575P	3 952,00 \$

2 WIRES + GROUND				
H.P.	G.P.M.	Part number	Model	Suggested list price
1/2	6	438-0010	FLS6-50-112P	1 340,00 \$
	6	438-0030	FLS6-50-232P	1 340,00 \$*
	10	438-0210	FLS10-50-112P	1 121,00 \$
	10	438-0230	FLS10-50-232P	1 097,00 \$*
	15	438-0410	FLS15-50-112P	1 185,00 \$
	15	438-0430	FLS15-50-232P	1 185,00 \$
3/4	6	438-1030	FLS6-75-232P	1 646,00 \$*
	10	438-1230	FLS10-75-232P	1 371,00 \$*
	15	438-1430	FLS15-75-232P	1 427,00 \$
	25	438-1630	FLS25-75-232P	1 409,00 \$
1	6	438-2030	FLS6-100-232P	1 984,00 \$
	10	438-2230	FLS10-100-232P	1 708,00 \$*
	15	438-2430	FLS15-100-232P	1 752,00 \$
	25	438-2630	FLS25-100-232P	1 702,00 \$
1 1/2	6	438-3030	FLS6-150-232P	2 464,00 \$
	10	438-3230	FLS10-150-232P	2 362,00 \$
	15	438-3430	FLS15-150-232P	2 252,00 \$
	25	438-3630	FLS25-150-232P	2 186,00 \$

* see net price list

† = available voltage
200 - 230 - 380 - 460 volts

WARNING:

These pumps may develop very high pressure. A pressure valve must be installed on the tank to avoid possible danger of the tank bursting, causing property damage and/or personal injury or death.



EXAMPLE OF MODEL NUMBER

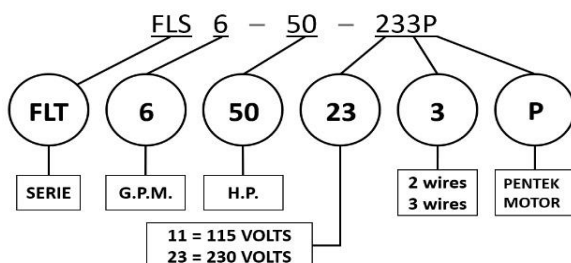

Powered by:



Intellidrive™ OVERLOAD PROTECTION

Part number	Model	Suggested list Price
153-1800	Overload protection input / output	416,00 \$
153-1810	Overload protection (input)	208,00 \$
153-1820	Overload protection (pump)	224,00 \$

PUMP + Intellidrive™ 3 phases

H.P.	G.P.M.	Stages	Ph.	Volts	Part number	Model	Suggested list price
1	6	8	3	230	438-2150	FLS6-100ID + PID10	4 063,00 \$ *
	10	6	3	230	438-2350	FLS10-100ID + PID10	3 751,00 \$ *
	15	4	3	230	438-2550	FLS15-100ID + PID10	3 971,00 \$ *
1 1/2	6	12	3	230	438-3150	FLS6-150ID + PID20	4 814,00 \$ *
	10	9	3	230	438-3350	FLS10-150ID + PID20	4 402,00 \$ *
	15	6	3	230	438-3550	FLS15-150ID + PID20	4 596,00 \$ *
	25	4	3	230	438-3750	FLS25-150ID + PID20	4 539,00 \$ *
2	6	15	3	230	438-4150	FLS6-200ID + PID20	5 033,00 \$ *
	10	11	3	230	438-4350	FLS10-200ID + PID20	4 652,00 \$ *
	15	7	3	230	438-4550	FLS15-200ID + PID20	4 777,00 \$ *
	25	5	3	230	438-4750	FLS25-200ID + PID20	4 739,00 \$ *
3	10	14	3	230	438-5350	FLS10-300ID + PID30	7 064,00 \$ *
	15	9	3	230	438-5550	FLS15-300ID + PID30	7 015,00 \$ *
	25	7	3	230	438-5750	FLS25-300ID + PID30	6 939,00 \$ *
5	15	16	3	230	438-6550	FLS15-500ID + PID50	8 901,00 \$ *
	25	10	3	230	438-6750	FLS25-500ID + PID50	8 689,00 \$ *

* see net price list



Part Number	Description	Suggested list price
023-1350	Support only	90,10 \$ *
120-7500	Tee Kit + accessories + tank WX-102	435,00 \$ *
120-7450	Tee kit + accessories + Tank in S/S	760,00 \$ *
120-7400	Tee + Tank ZHP12	310,00 \$ *

* see net price list

TANK SELECTION

* Minimum 2 gallons capacity tank should be used with an Intellidrive™.
 * Minimum tank sizing should be 20% of rated Pump GPM, but never less than 2 gallons.

Example:

- * A 10GPM pump, should use a minimum 2 gallons tank.
- * A 50GPM pump, should use a minimum 10 gallons tank.
- * A bigger tank will reduce the rapid cycling of the pump.





Constant pressure control Intellidrive



Features

Voltage correction:

Input voltage 190V and 265V - 1 phase
Output voltage constant at 230V for the motor

Pump/motor

Internal protection to increase the life of your investment

Surge protection
Open/Short circuit
Under load / Under voltage / Overheated controller/
Locked pump

Pressure control device

Resistive transducer pieces for precise pressure control, greater dependability and protection against water hammer.

Fully programmable drive

Easily programmable for a variety of applications and specific settings

Diagnostics

LCD display provides on-demand information for easy diagnostics and troubleshooting.

EMI/RFI filters

Best in the industry to eliminate potential interference easy-access conduit holes align with appropriate terminal blocks for straight-in accessibility.

Connections

Easy-access conduit holes align with appropriate terminal blocks for straight-in accessibility.

Terminal blocks

Removable and replaceable terminal blocks for ease of wiring motor and power supply.

Fan

Temperature-sensitive intelligent fan operates as necessary, conserving energy and maintenance costs.

Specification

Dimension

Width: 9.25 in Height: 17.5 in Depth: 6 in

Characteristics

3 models that will meet all your needs, reducing inventory requirements and simplifying product selection

Operating range

2 or 3 wires compatible, 1 phase Output (60 Hz)/ 3 phases Output (60 Hz / 80 Hz)

Languages

English, French and Spanish.

Compatible with Franklin electric motors

Part number	Model	Motor Type	HP Range	Input voltage	Maximum output amps	Enclose type	Suggested list Price
153-1500	PID10	2 wire [#] 1 phase	0.5 - 1 HP	190V - 265V	9.5 A	NEMA 3R outdoor	2 323,00 \$ *
		3 wire [#] 1 phase	0.5 - 1 HP		7.5 A		
		3 phase	0.5 - 1 HP		5 A		
153-1550	PID20	2 wire [#] 1 phase	0.5 - 1½ HP		11 A		2 792,00 \$ *
		3 wire [#] 1 phase	0.5 - 2 HP		13.5 A		
		3 phase	0.5 - 2 HP		8.5 A		
153-1575	PID30	3 phase	0.5 - 3 HP		11.5 A		4 418,00 \$ *
153-1600	PID50	3 phase	0.5 - 5 HP		18 A		5 077,00 \$ *

Select drives by S.F. amps of pump motor

* see net price list

4" Submersible Pump



Solid of its 40 years of experience, Pomppo is proud to present its new submersible pumps of the FLS and FLT series.

Designed, developed and manufactured by a team of experts who have been able to anticipate and meet all your possible needs in terms of submersible pumps.

Its main features are:

- *Higher efficiency than equivalent pumps on the market;
- *Increased resistance to the wear of time;

The new submersible pump of the FLT series is synonymous with efficiency, durability, reliability and performance. In other words, they are synonymous with Pomppo.

NEW
Better Efficiency
New Design

Motor by:



Other motors optional. Consult factory

Part	FLT Series Thermoplastic
Check valve	Internal check valve made of Polypropylene + fibers.
Discharge head & Motor bracket	Made of Polypropylene + fibers.
Shaft	Hexagonal shaft made of (303) stainless steel for corrosion and wear resistance
Couplings	Made of stainless steel and fit perfectly to any 4" standard motor which allows maximum efficiency.
Diffuser *	Injection molded in engineering composite.
Washer	Made of stainless steel, they prevent wearing of the impellers and diffusers.
Impeller *	Injection molded in Acetal. (Four colors for a better identification)
Disc*	Made of stainless steel.
Top bearing	Injection molded in Polypropylene plus fibers, with a rubber centre for an even more precise alignment of the shaft. The rubber center considerably reduces wearing of the shaft caused by sand.
Screen	Made of stainless steel, it prevents the impellers from large debris obstructions.
Cable guard	Made of stainless steel, corrosion resistant, protects motor lead.
Housing	Made of (T-304) stainless steel, it is threaded for easy maintenance.
Fasteners	All stainless steel fasteners.



On 1/2, 3/4 & 1 HP pumps & motors



4" submersible pump **FLT**

Thermoplastic FLT series 6-10-15-25 G.P.M.

Control box included ONLY with 3 wires motors

					3 WIRES + GROUND		
H.P.	GPM	Stages	PH	Volts	Part number	Model	Suggested list price
1/2	6	11	1	115	465-0020	FLT6-50-113P	1 164,00 \$
	6	11	1	230	465-0040	FLT6-50-233P	1 164,00 \$ *
	10	9	1	115	465-0220	FLT10-50-113P	977,00 \$
	10	9	1	230	465-0240	FLT10-50-233P	977,00 \$ *
	15	6	1	115	465-0420	FLT15-50-113P	1 077,00 \$
	15	6	1	230	465-0440	FLT15-50-233P	1 077,00 \$
3/4	6	15	1	230	465-1040	FLT6-75-233P	1 440,00 \$ *
	10	12	1	230	465-1240	FLT10-75-233P	1 190,00 \$ *
	15	7	1	230	465-1440	FLT15-75-233P	1 264,00 \$
	25	5	1	230	465-1640	FLT25-75-233P	1 245,00 \$
1	6	18	1	230	465-2040	FLT6-100-233P	1 624,00 \$
	10	14	1	230	465-2240	FLT10-100-233P	1 371,00 \$
	15	9	1	230	465-2440	FLT15-100-233P	1 352,00 \$
	25	6	1	230	465-2640	FLT25-100-233P	1 352,00 \$
1-1/2	10	19	1	230	465-3240	FLT10-150-233P	1 908,00 \$
	15	12	1	230	465-3440	FLT15-150-233P	1 833,00 \$
	25	8	1	230	465-3640	FLT25-150-233P	1 765,00 \$

					2 WIRES + GROUND		
H.P.	GPM	Part number	Model	Suggested list price			
1/2	6	465-0010	FLT6-50-112P	1 127,00 \$			
	6	465-0030	FLT6-50-232P	1 127,00 \$ *			
	10	465-0210	FLT10-50-112P	946,00 \$			
	10	465-0230	FLT10-50-232P	946,00 \$ *			
	15	465-0410	FLT15-50-112P	1 058,00 \$			
	15	465-0430	FLT15-50-232P	1 058,00 \$			
3/4	6	465-1030	FLT6-75-232P	1 434,00 \$ *			
	10	465-1230	FLT10-75-232P	1 185,00 \$ *			
	15	465-1430	FLT15-75-232P	1 259,00 \$			
	25	465-1630	FLT25-75-232P	1 240,00 \$			
1	6	465-2030	FLT6-100-232P	1 870,00 \$			
	10	465-2230	FLT10-100-232P	1 596,00 \$			
	15	465-2430	FLT15-100-232P	1 577,00 \$			
	25	465-2630	FLT25-100-232P	1 584,00 \$			
1-1/2	10	465-3230	FLT10-150-232P	2 152,00 \$			
	15	465-3430	FLT15-150-232P	1 965,00 \$			
	25	465-3630	FLT25-150-232P	2 009,00 \$			

* see net price

Powered by:



EXAMPLE OF MODEL NUMBER

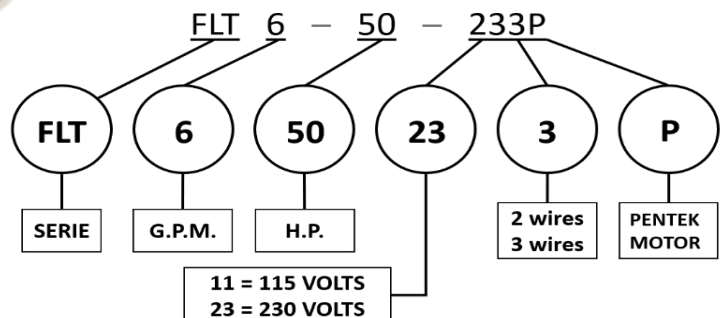

4" Pump End

For FLS and FLT submersible pump series 6-10-15-25



Pump End "FLS" Series					
H.P.	GPM	St.	Part number	Model	Suggested list price
1/2	6	11	441-3000	FLS6-50	942,00 \$
	10	9	441-3200	FLS10-50	771,00 \$
	15	6	441-3400	FLS15-50	782,00 \$
3/4	6	15	441-3005	FLS6-75	1 109,00 \$
	10	12	441-3205	FLS10-75	895,00 \$
	15	7	441-3405	FLS15-75	871,00 \$
	25	5	441-3605	FLS25-75	834,00 \$
1	6	18	441-3010	FLS6-100	1 210,00 \$
	10	14	441-3210	FLS10-100	1 022,00 \$
	15	9	441-3410	FLS15-100	1 000,00 \$
	25	6	441-3610	FLS25-100	900,00 \$
1½	6	23	441-3015	FLS6-150	1 406,00 \$
	10	19	441-3215	FLS10-150	1 203,00 \$
	15	12	441-3415	FLS15-150	1 080,00 \$
	25	8	441-3615	FLS25-150	1 006,00 \$
2	10	23	441-3220	FLS10-200	1 376,00 \$
	15	15	441-3420	FLS15-200	1 216,00 \$
	25	10	441-3620	FLS25-200	1 067,00 \$
3	10	31	441-3225	FLS10-300	1 709,00 \$
	15	20	441-3425	FLS15-300	1 456,00 \$
	25	14	441-3625	FLS25-300	1 222,00 \$
5	15	32	441-3430	FLS15-500	1 722,00 \$
	25	21	441-3630	FLS25-500	1 554,00 \$

ROTATING KIT				
H.P.	GPM	STAGES	PART #	Suggested list price
1/2	6	11	542-1000	318,00 \$
	10	9	542-1200	266,00 \$
	15	6	542-1400	228,00 \$
3/4	6	15	542-1005	410,00 \$
	10	12	542-1205	330,00 \$
	15	7	542-1405	258,00 \$
	25	5	542-1605	212,00 \$
1	6	18	542-1010	477,00 \$
	10	14	542-1210	375,00 \$
	15	9	542-1410	311,00 \$
	25	6	542-1610	237,00 \$
1-1/2	6	23	542-1015	597,00 \$
	10	19	542-1215	479,00 \$
	15	12	542-1415	386,00 \$
	25	8	542-1615	291,00 \$
2	10	23	542-1220	573,00 \$
	15	15	542-1420	456,00 \$
	25	10	542-1620	341,00 \$
3	10	31	542-1225	748,00 \$
	15	20	542-1425	597,00 \$
	25	14	542-1625	456,00 \$
5	15	32	542-1430	906,00 \$
	25	21	542-1630	646,00 \$

Pump End "FLT" Series					
H.P.	GPM	St.	Part number	Model	Suggested list price
1/2	6	11	441-6000	FLT6-50	603,00 \$
	10	9	441-6200	FLT10-50	489,00 \$
	15	6	441-6400	FLT15-50	525,00 \$
3/4	6	15	441-6005	FLT6-75	722,00 \$
	10	12	441-6205	FLT10-75	562,00 \$
	15	7	441-6405	FLT15-75	514,00 \$
	25	5	441-6605	FLT25-75	587,00 \$
1	6	18	441-6010	FLT6-100	857,00 \$
	10	14	441-6210	FLT10-100	679,00 \$
	15	9	441-6410	FLT15-100	628,00 \$
	25	6	441-6610	FLT25-100	574,00 \$
1½	10	23	441-6215	FLT10-150	835,00 \$
	15	12	441-6415	FLT15-150	724,00 \$
	25	8	441-6615	FLT25-150	655,00 \$





4" Submersible Pump

FP Series 35-50-80 G.P.M.

230 Volts - 1 phase					
H.P.	GPM	St.	Part number	Model	Suggested list price
1	35	4	434-0010	4 FP-35-10-233P	1 772,00 \$
1½	35	6	434-0050	4 FP-35-15-233P	2 282,00 \$
	50	4	434-0090	4 FP-50-15-233P	2 165,00 \$
2	35	8	434-0130	4 FP-35-20-233P	2 784,00 \$
	50	5	434-0170	4 FP-50-20-233P	2 657,00 \$
	80	4	434-0200	4 FP-80-20-233P	2 669,00 \$
3	35	11	434-0210	4 FP-35-30-233P	3 902,00 \$
	50	7	434-0250	4 FP-50-30-233P	3 759,00 \$
	80	5	434-0290	4 FP-80-30-233P	3 723,00 \$
5	35	18	434-0330	4 FP-35-50-233P	5 416,00 \$
	50	12	434-0370	4 FP-50-50-233P	5 217,00 \$
	80	7	434-0410	4 FP-80-50-233P	5 168,00 \$
7½	35	27	-	-	
	50	17	-	-	
	80	14	-	-	

575 Volts - 3 phases		
Part number	Model	Suggested list price
-	-	
434-0070	4 FP-35-15-575P	1 855,00 \$
434-0110	4 FP-50-15-575P	1 738,00 \$
434-0150	4 FP-35-20-575P	2 086,00 \$
434-0190	4 FP-50-20-575P	1 965,00 \$
434-0205	4 FP-80-20-575P	1 977,00 \$
434-0230	4 FP-35-30-575P	2 805,00 \$
434-0270	4 FP-50-30-575P	2 664,00 \$
434-0310	4 FP-80-30-575P	2 628,00 \$
434-0350	4 FP-35-50-575P	4 208,00 \$
434-0390	4 FP-50-50-575P	3 999,00 \$
434-0430	4 FP-80-50-575P	3 947,00 \$
434-0470	4 FP-35-75-575P	5 485,00 \$
434-0510	4 FP-50-75-575P	4 799,00 \$
434-0550	4 FP-80-75-575P	4 859,00 \$



Control box INCLUDED with 3 wire motors



CHARACTERISTICS

- Impellers and diffusers made of polycarbonate
- Pump shaft and shell made of 304 stainless steel
- Internal check valve included
- Discharge = 2"
- Maximum starts in an hour = 15

EXAMPLE OF MODEL NUMBER

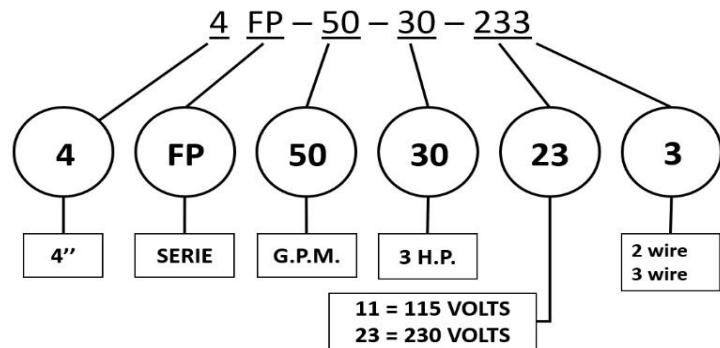

6" submersible pump AP (50-75-120-170-230 GPM)



PUMP ONLY					
H.P.	GPM	St.	Part number	Model	Suggested list price
5	50	6	547-0900	46 AP-50-50	3 520,00 \$
	50	6	547-0910	66 AP-50-50	3 520,00 \$
	75	4	547-0920	46 AP-75-50	2 900,00 \$
	75	4	547-0930	66 AP-75-50	2 900,00 \$
7½	50	10	547-0940	46 AP-50-75	2 570,00 \$
	50	10	547-0950	66 AP-50-75	3 339,00 \$
	75	6	547-0960	46 AP-75-75	3 575,00 \$
	75	6	547-0970	66 AP-75-75	3 339,00 \$
	120	3	547-1010	46 AP-120-75	2 923,00 \$
	120	3	547-1050	66 AP-120-75	2 378,00 \$
	170	2	547-1090	46 AP-170-75	2 673,00 \$
	170	2	547-1130	66 AP-170-75	2 673,00 \$
10	50	10	547-1140	66 AP-50-100	2 673,00 \$
	75	8	547-1150	66 AP-75-100	4 072,00 \$
	120	5	547-1170	66 AP-120-100	3 345,00 \$
	170	3	547-1210	66 AP-170-100	2 964,00 \$
	230	3	547-1250	66 AP-230-100	2 950,00 \$
15	50	16	547-1260	66 AP-50-150	6 028,00 \$
	75	12	547-1270	66 AP-75-150	4 976,00 \$
	120	7	547-1290	66 AP-120-150	3 952,00 \$
	170	5	547-1320	66 AP-170-150	3 380,00 \$
	230	4	547-1370	66 AP-230-150	3 262,00 \$
20	75	16	547-1390	66 AP-75-200	6 204,00 \$
	120	10	547-1410	66 AP-120-200	4 813,00 \$
	170	7	547-1450	66 AP-170-200	4 187,00 \$
	230	6	547-1490	66 AP-230-200	4 192,00 \$
25	75	20	547-1510	66 AP-75-250	7 224,00 \$
	120	12	547-1530	66 AP-120-250	5 308,00 \$
	170	8	547-1570	66 AP-170-250	4 609,00 \$
	230	7	547-1610	66 AP-230-250	4 198,00 \$
30	120	15	547-1650	66 AP-120-300	6 249,00 \$
	170	10	547-1690	66 AP-170-300	5 151,00 \$
	230	9	547-1730	66 AP-230-300	5 141,00 \$
40	230	12	547-1840	66 AP-230-400	5 948,00 \$

CHARACTERISTICS

- Impellers and diffusers made of Noryl
- Pump shaft and shell made of 304 stainless steel
- Internal check valve included
- Discharge = 3"
- Maximum starts in an hour = 15

4" MOTOR				
Part number	H.P.	Volts	Phase	Suggested list price
153-0450	5	230	3	2 633,00 \$
153-0460	5	575	3	2 633,00 \$
153-0470	7.5	230	3	3 284,00 \$
153-0480	7.5	575	3	3 284,00 \$

6" MOTOR				
Part number	H.P.	Volts	Phase	Suggested list price
153-0800	5	230	1	270,00 \$
153-0810	5	230	1	3 108,00 \$
153-0820	5	230	3	3 299,00 \$
153-0840	5	575	3	3 299,00 \$
153-0860	7,5	230	1	4 226,00 \$
153-0870	7.5	230	3	3 343,00 \$
153-0880	7.5	575	3	3 809,00 \$
153-0890	10	230	1	4 615,00 \$
153-0900	10	230	3	4 511,00 \$
153-0920	10	575	3	4 511,00 \$
153-0930	15	230	3	5 190,00 \$
153-0940	15	575	3	5 190,00 \$
153-0950	20	230	3	6 465,00 \$
153-0960	20	575	3	6 465,00 \$
153-0970	25	230	3	7 423,00 \$
153-0980	25	575	3	7 423,00 \$
153-0990	30	330	3	8 610,00 \$
153-1000	30	575	3	8 610,00 \$
153-1010	40	230	3	10 503,00 \$
153-1020	40	575	3	10 503,00 \$



EXAMPLE OF MODEL NUMBER

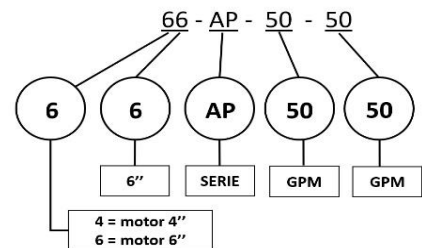

* Available (200, 230, 380, 460V - 3 phase) on request



Performance charts

Series FLS & FLT - 6 GPM

CAPACITY IN U.S. GALLONS / HOUR

Model	Motor H.P.	Depth To Pumping Water level (Lift) in feet.																Shut off head	
		P.S.I.	20	40	60	80	100	125	150	175	200	225	250	275	300	350	400	Feet	P.S.I.
6-50 11 Stages	1/2	30	534	514	490	466	442	413	384	349	302	231	123					334	145
		40	510	486	462	438	415	386	352	306	237	133							
		50	483	458	435	412	389	355	310	244	143								
		60	455	431	408	385	358	314	250	152									
		70	428	405	381	354	318	256	161										
6-75 15 Stages	3/4	30	538	526	511	495	478	457	437	417	396	373	346	311	264	117		450	195
		40	524	509	492	475	459	438	418	398	375	348	314	268	207				
		50	506	490	473	456	440	420	399	377	350	317	272	212	131				
		60	487	470	453	437	421	401	379	353	320	276	217	138					
		70	468	451	435	419	403	381	355	323	280	223	145						

Model	Motor H.P.	Depth To Pumping Water level (Lift) in feet.																Shut off head	
		P.S.I.	100	125	150	175	200	225	250	275	300	350	400	450	500	550	600	Feet	P.S.I.
6-100 18 Stages	1	30	513	494	474	455	436	417	397	376	352	290	193	40				551	239
		40	495	476	456	437	418	399	378	354	327	251	131						
		50	477	458	439	420	400	379	356	329	296	203	55						
		60	459	440	421	402	381	358	331	299	258	143							
		70	442	423	403	383	360	334	301	262	211	69							
6-150 23 Stages	1½	30	540	526	510	494	478	461	444	426	407	366	315	248	158	35		708	307
		40	527	511	495	479	462	445	427	409	389	344	286	210	106				
		50	513	497	480	464	446	429	410	390	369	319	254	166	46				
		60	498	482	465	448	430	412	392	371	347	291	217	116					
		70	483	466	449	431	413	393	372	349	323	260	174	57					

Numbers in **italic-bold** indicate the maximum efficiency zone

To convert **feet** in **meters** multiply by 0.3048

To convert **U.S. gallon** in **Liters** multiply by 3.785

Pumping curves

FLS & FLT series - 6 GPM

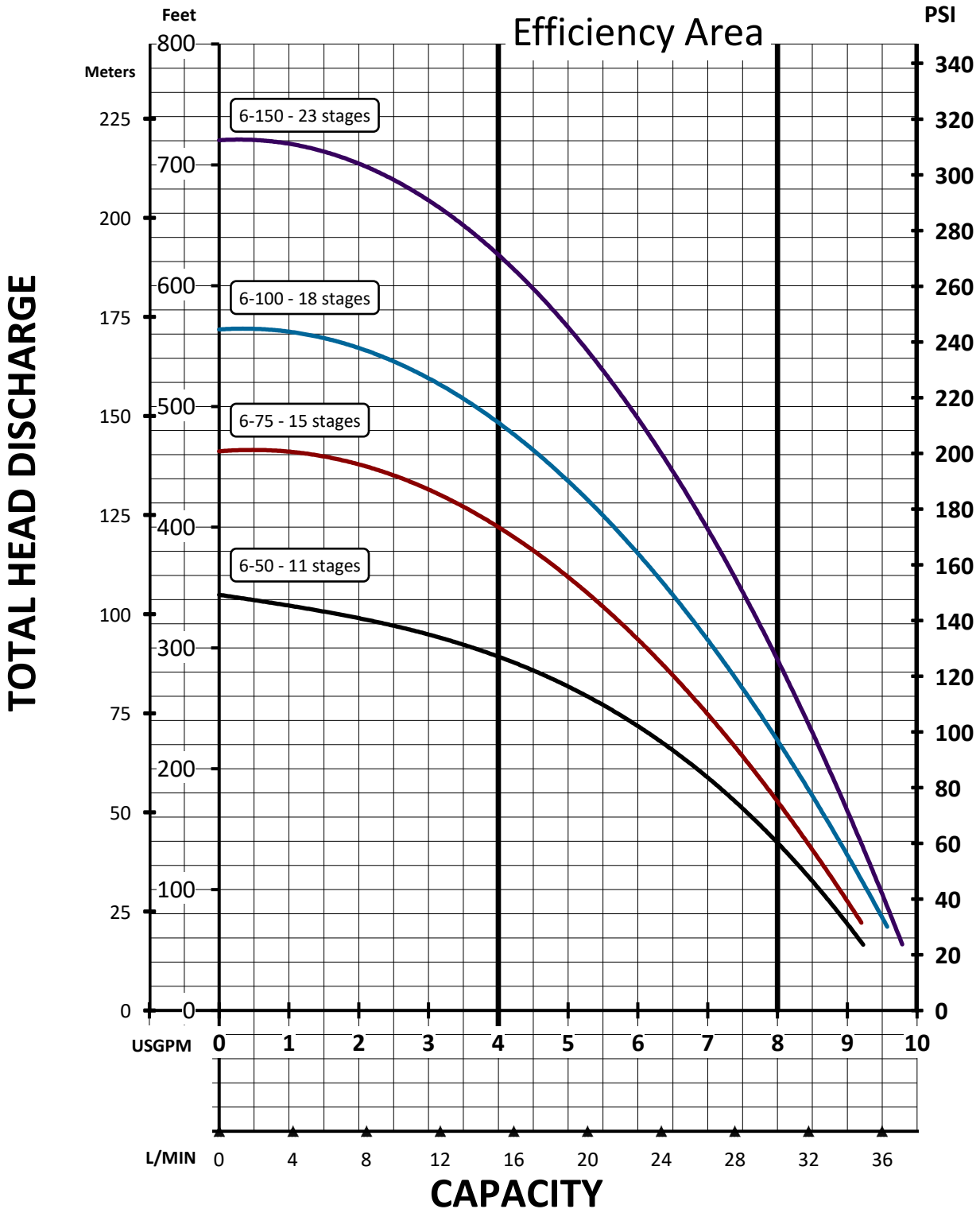



Performance charts

FLS & FLT series - 10 GPM

CAPACITY IN U.S. GALLONS / HOUR

Model	Motor H.P.	Depth To Pumping Water level (Lift) in feet.																Shut off head	
		P.S.I.	20	40	60	80	100	125	150	175	200	225	250	275	300	350	400	Feet	P.S.I.
10-50 9 Stages	1/2	30	771	728	692	658	622	569	499	404	278	111						305	132
		40	723	687	652	616	573	505	413	289	126								
		50	681	647	610	566	511	421	300	140									
		60	642	604	558	501	429	310	154										
		70	597	550	491	416	321	168											
10-75 12 Stages	3/4	30	810	781	755	731	707	676	642	602	553	495	423	337	233			409	177
		40	777	751	727	703	679	645	605	557	500	429	344	242	119				
		50	748	723	700	675	647	608	561	505	435	351	250	130					
		60	720	696	671	643	612	565	509	441	358	259	140						
		70	692	667	638	606	569	514	447	365	267	150							
10-100 14 Stages	1	30	835	805	778	754	732	705	679	651	620	585	545	497	440	295	98	482	209
		40	801	774	750	728	707	681	653	623	588	548	501	445	379	211			
		50	771	747	725	704	683	655	625	591	551	505	450	385	308	115			
		60	744	722	701	679	657	628	594	555	509	454	390	315	226				
		70	718	697	676	654	630	597	558	512	459	395	321	234	132				

Model	Motor H.P.	Depth To Pumping Water level (Lift) in feet.																Shut off head	
		P.S.I.	150	175	200	225	250	275	300	350	400	450	500	550	600	700	800	Feet	P.S.I.
10-150 19 Stages	1½	30	726	711	695	678	660	639	616	560	487	396	281	140				653	283
		40	712	697	680	661	641	618	592	528	448	346	219	64					
		50	698	681	663	643	620	594	564	494	404	291	152						
		60	683	664	644	622	596	567	534	455	355	230	78						
		70	666	646	623	598	569	537	500	411	301	163							
10-200 23 Stages	2	30	758	744	730	715	700	684	667	628	583	527	461	380	284			769	333
		40	745	731	716	701	685	668	650	608	558	498	425	338	233				
		50	732	717	702	686	669	651	631	586	532	466	387	292	179				
		60	718	703	687	671	653	633	612	563	503	431	345	242	120				
		70	704	689	672	654	635	613	590	537	472	394	300	188					

Model	Motor H.P.	Depth To Pumping Water level (Lift) in feet.																Shut off head	
		P.S.I.	200	225	250	275	300	350	400	450	500	550	600	700	800	900	1000	Feet	P.S.I.
10-300 31 Stages	3	30	767	759	751	743	735	719	701	681	657	629	596	510	394	239	37	1083	470
		40	760	752	744	736	728	711	692	670	645	614	578	487	362	196			
		50	752	744	737	729	720	702	682	659	631	599	560	461	327	152			
		60	745	737	729	721	712	694	672	647	617	581	540	433	291	105			
		70	738	730	722	713	704	684	661	634	601	563	518	404	252	55			

Numbers in **italic-bold** indicate the maximum efficiency zone
 To convert **feet** in **meters** multiply by 0.3048
 To convert **U.S. gallon** in **Liters** multiply by 3.785

Pumping curves

FLS & FLT series - 10 GPM

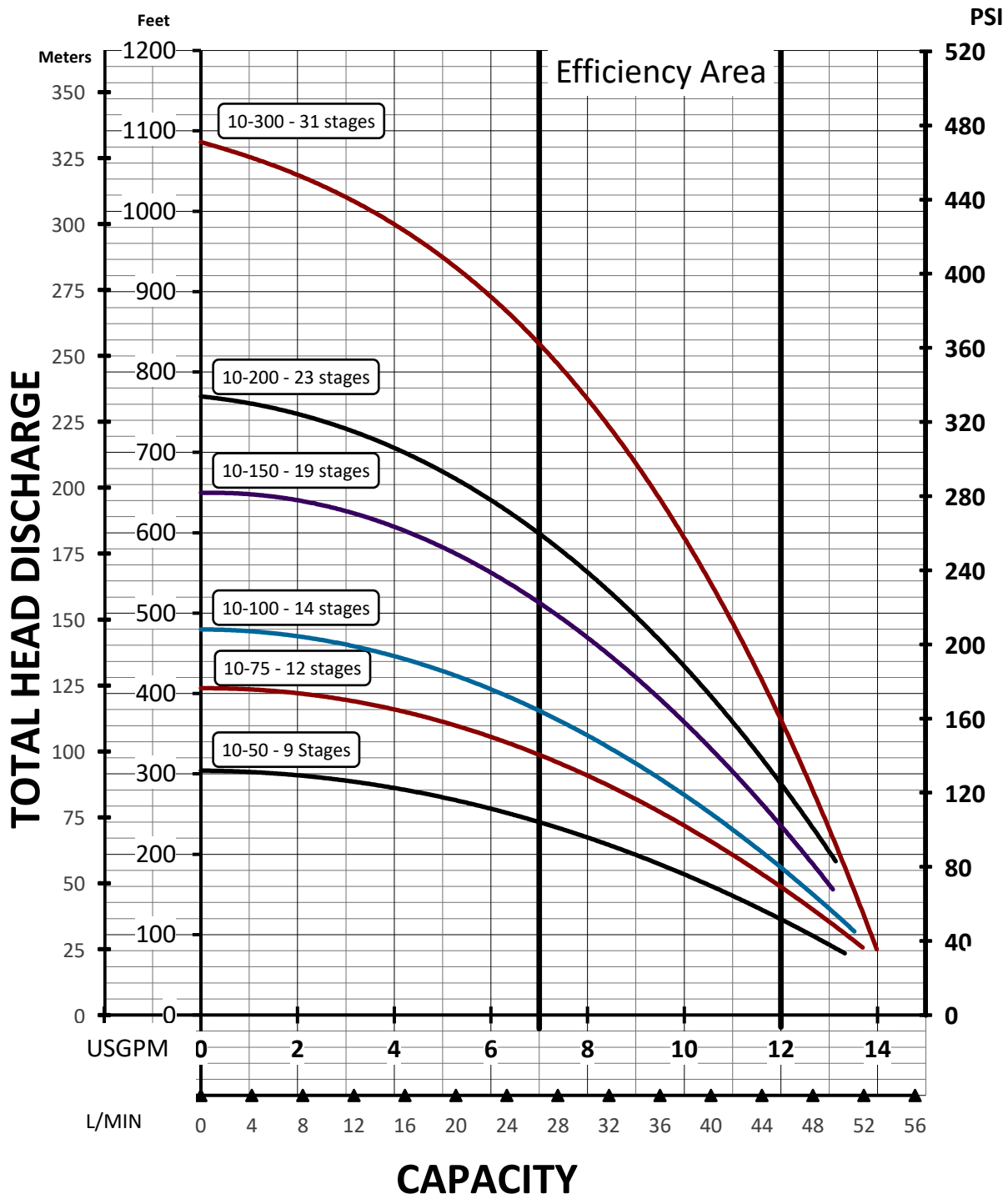



Performance charts

FLS & FLT series - 15 GPM

CAPACITY IN U.S. GALLONS / HOUR

Model	Motor H.P.	Depth To Pumping Water level (Lift) in feet.														Shut off head		
		P.S.I.	20	40	60	80	100	125	150	175	200	225	250	275	300	350	Feet	P.S.I.
15-50 6 Stages	1/2	30	1135	1042	921	773	598	341	41								220	95
		40	1025	900	748	569	363	66										
		50	879	723	539	329	91											
		60	696	509	294													
		70	478	259														
15-75 7 Stages	3/4	30	1232	1166	1080	976	853	672	462	221							263	114
		40	1154	1066	958	832	687	479	241									
		50	1050	940	811	663	496	261										
		60	922	790	639	469	280											
		70	768	614	441	249												
15-100 9 Stages	1	30	1311	1272	1222	1161	1089	984	861	721	564	389	197				339	147
		40	1265	1214	1151	1077	993	871	732	576	403	212						
		50	1205	1140	1065	979	881	744	589	417	228							
		60	1130	1053	964	865	755	602	431	243	38							
		70	1040	950	849	737	614	445	258	54								

Model	Motor H.P.	Depth To Pumping Water level (Lift) in feet.														Shut off head		
		P.S.I.	80	100	125	150	175	200	225	250	275	300	350	400	450	500	Feet	P.S.I.
15-150 12 Stages	1½	30	1276	1237	1180	1113	1037	953	858	755	643	521	251				453	196
		40	1230	1184	1119	1044	959	866	764	652	531	401	113					
		50	1177	1124	1050	966	874	772	661	541	411	273						
		60	1115	1056	973	881	780	670	550	422	284	137						
		70	1046	980	889	788	679	560	432	295	149							
15-200 20 Stages	2	30	1309	1282	1242	1197	1147	1091	1030	963	891	813	641	448	232		559	242
		40	1277	1245	1201	1151	1095	1035	968	896	819	736	555	351	125			
		50	1240	1204	1155	1100	1039	974	902	825	743	655	463	250				
		60	1199	1159	1104	1044	979	908	831	750	662	569	367	144				
		70	1153	1109	1049	984	914	838	756	669	577	479	267	33				

Model	Motor H.P.	Depth To Pumping Water level (Lift) in feet.														Shut off head		
		P.S.I.	200	225	250	275	300	350	400	450	500	550	600	700	800	900	Feet	P.S.I.
15-300 20 Stages	3	30	1264	1234	1201	1164	1124	1034	930	814	684	541	385				768	333
		40	1237	1203	1167	1127	1084	987	878	755	620	471	309					
		50	1206	1170	1130	1087	1041	939	823	695	553	398	229					
		60	1173	1133	1091	1045	995	887	765	631	483	322	147					
		70	1136	1094	1048	999	947	833	705	564	410	243						

Model	Motor H.P.	Depth To Pumping Water level (Lift) in feet.														Shut off head		
		P.S.I.	250	275	300	350	400	450	500	550	600	700	800	900	1000	1100	Feet	P.S.I.
15-500 31 Stages	3/4	30	1340	1323	1305	1266	1224	1176	1125	1069	1010	877	728	562	379	179	1226	532
		40	1324	1307	1288	1247	1202	1153	1100	1042	981	844	691	521	334	130		
		50	1308	1289	1270	1227	1180	1129	1074	1014	951	811	653	479	288	81		
		60	1291	1271	1250	1206	1157	1104	1047	986	920	776	615	437	242			
		70	1273	1252	1230	1184	1133	1078	1019	956	888	740	575	393	195			

Numbers in **italic-bold** indicate the maximum efficiency zone

To convert **feet** in **meters** multiply by 0.3048

To convert **U.S. gallon** in **Liters** multiply by 3.785

Pumping curves

FLS & FLT series - 15 GPM

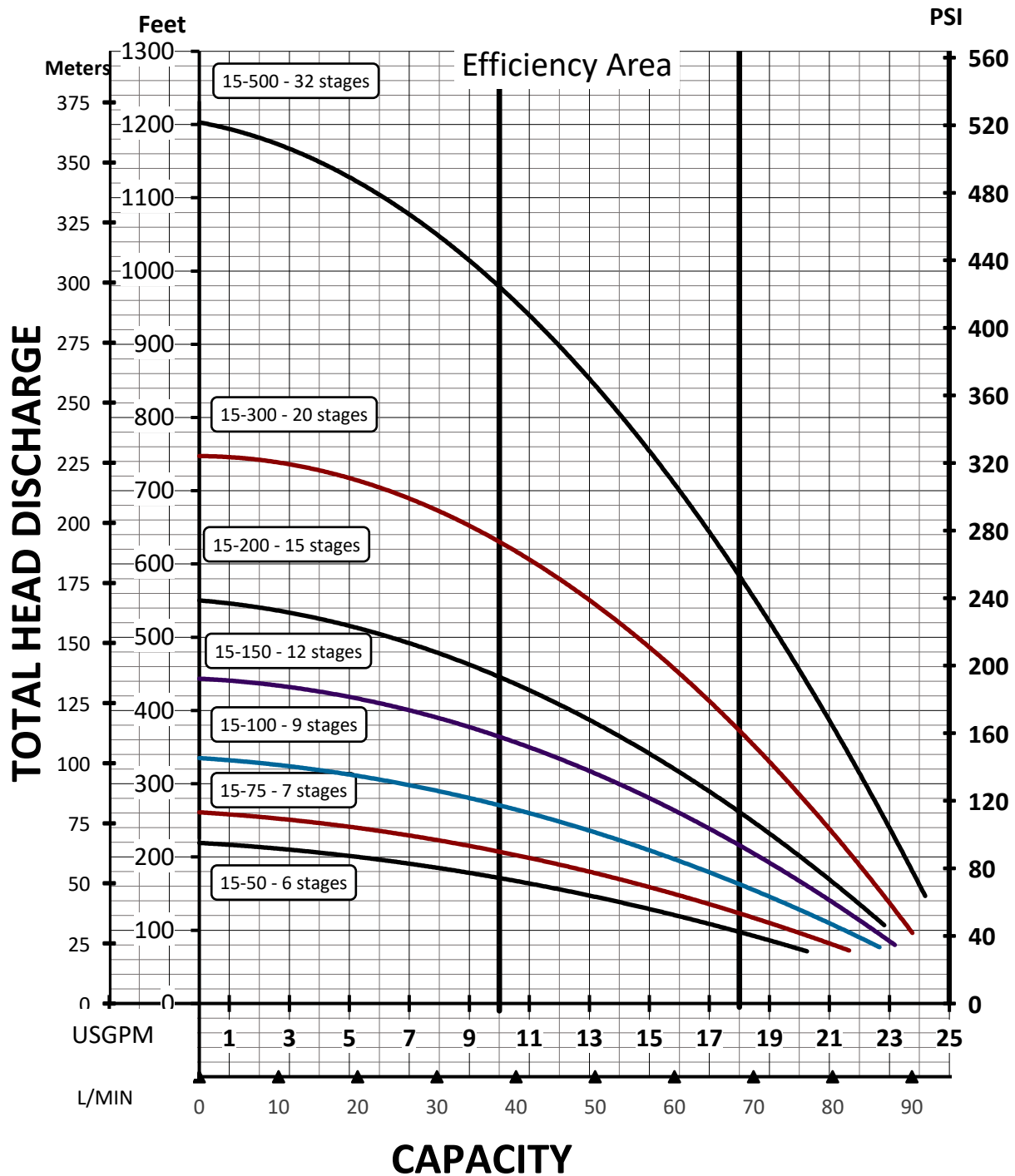



Performance charts

FLS & FLT series - 25 GPM

CAPACITY IN U.S. GALLONS / HOUR

Model	Motor H.P.	Depth To Pumping Water level (Lift) in feet.															Shut off head	
		P.S.I.	20	40	60	80	100	125	150	175	200	225	250	275	300	350	Feet	P.S.I.
25-100 6 Stages	1	30	1633	1514	1380	1241	1081	798	313								230	100
		40	1494	1360	1218	1053	825	361										
		50	1339	1195	1023	781	407											
		60	1171	992	734	333												
		70	959	684	253													
25-150 8 Stages	1½	30	1784	1711	1633	1552	1468	1353	1213	1025	758	374				310	134	
		40	1699	1620	1539	1454	1362	1225	1042	783	409							
		50	1608	1526	1441	1347	1237	1058	806	443								
		60	1514	1427	1332	1218	1074	829	476									
		70	1413	1316	1198	1049	851	508										
25-200 10 Stages	2	30	1790	1744	1687	1625	1560	1477	1392	1301	1195	1061	885	645	319	384	166	
		40	1736	1678	1615	1550	1483	1399	1308	1203	1073	901	667	348				
		50	1669	1605	1540	1473	1405	1315	1212	1084	916	688	376					
		60	1595	1529	1463	1395	1323	1221	1095	931	708	404						
		70	1519	1453	1384	1311	1230	1106	945	728	431							
25-300 14 Stages	3	30	1847	1819	1784	1743	1699	1642	1583	1523	1463	1400	1332	1255	1167	929	514	223
		40	1814	1778	1737	1692	1647	1588	1528	1467	1405	1337	1262	1174	1069	780		
		50	1772	1730	1686	1639	1592	1533	1472	1410	1342	1268	1181	1078	951	598		
		60	1723	1679	1632	1585	1537	1477	1415	1348	1274	1189	1087	962	807	374		
		70	1672	1625	1578	1530	1482	1419	1353	1280	1196	1095	972	820	631	102		

Model	Motor H.P.	Depth To Pumping Water level (Lift) in feet.															Shut off head	
		P.S.I.	175	200	225	250	275	300	350	400	450	500	550	600	650	700	Feet	P.S.I.
25-500 21 Stages	5	30	1705	1675	1645	1615	1586	1559	1507	1459	1412	1360	1298	1218	1108	958	827	359
		40	1677	1647	1617	1589	1561	1535	1485	1437	1389	1333	1264	1171	1045	872		
		50	1649	1620	1591	1563	1537	1511	1463	1415	1364	1304	1225	1118	972	773		
		60	1622	1593	1565	1539	1513	1489	1441	1393	1338	1270	1180	1056	887	659		
		70	1595	1567	1541	1515	1490	1467	1419	1369	1309	1232	1128	985	790	529		

Numbers in **italic-bold** indicate the maximum efficiency zone

To convert **feet** in **meters** multiply by 0.3048

To convert **U.S. gallon** in **Liters** multiply by 3.785

Pumping curves

FLS & FLT series - 25 GPM

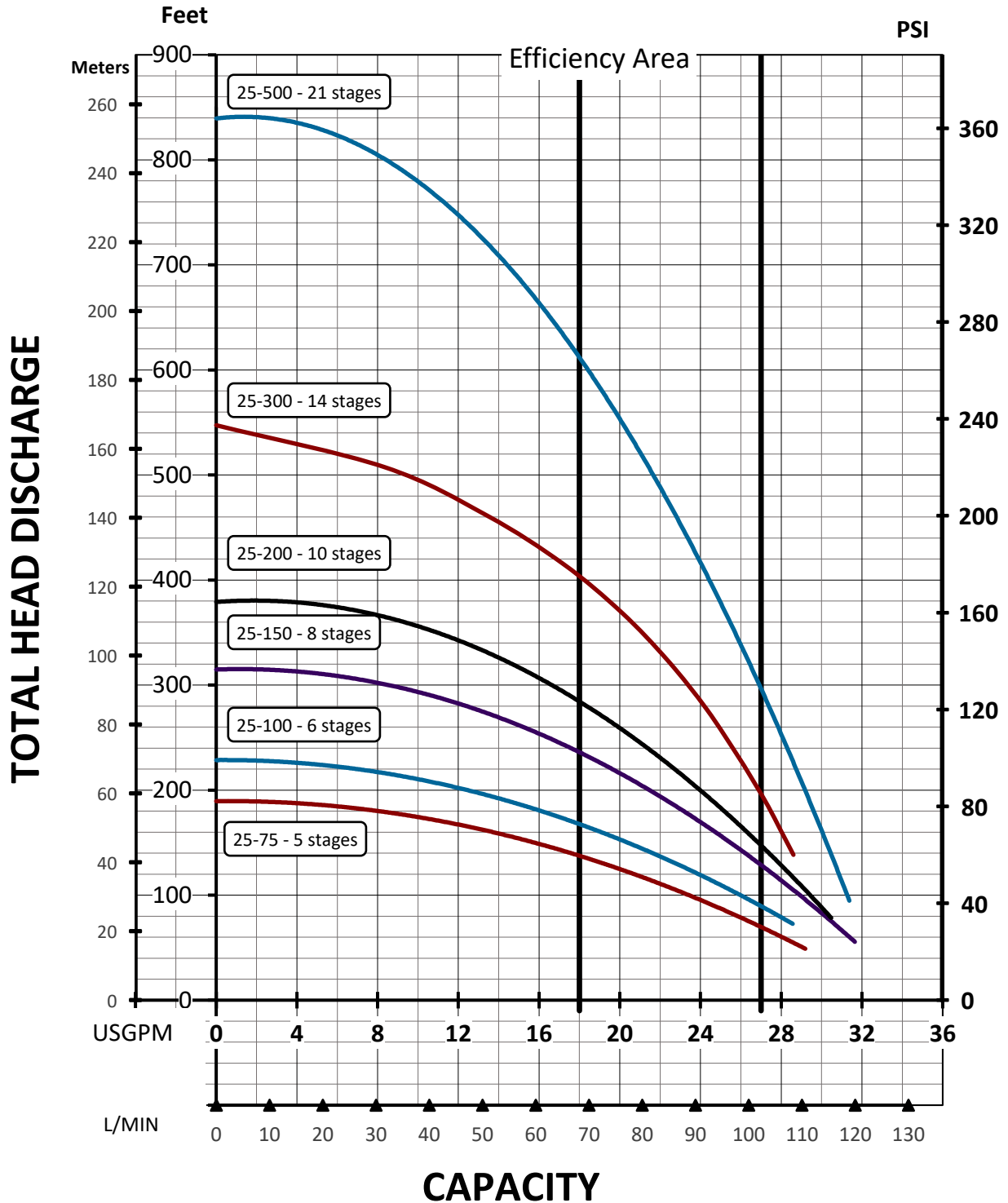



Performance charts

FP series - 35 GPM

Model	Motor H.P.	Water depth in FEET capacity in GPM														Shut off head	
		P.S.I.	20	40	60	80	100	120	140	160						Feet	P.S.I.
4FP-35-10 4 Stages	1	20	42	36	21											127	55
		30	36	19													
4FP-35-15 6 Stages	1 ½	20	47	45	39	36	27	18							190	82	
		30	45	38	35	26	15										
		40	38	33	26	13											
4FP-35-20 8 Stages	2	20	51	48	45	42	38	34	30	22					250	108	
		30	48	45	42	37	34	28	22	12							
		40	45	42	38	33	27	22	10								
		50	41	36	33	28	22	10									
		60	35	32	27	17	6										

Model	Motor H.P.	Water depth in FEET capacity in GPM														Shut off head	
		P.S.I.	50	75	100	125	150	175	200	225	250					Feet	P.S.I.
4FP-35-30 11 Stages	3	20	52	49	46	43	39	35	31	25	17				350	151	
		30	50	46	43	39	35	31	24	15							
		40	47	44	40	37	32	26	20								
		50	44	40	37	31	25	19									
		60	41	37	30	25	20										
		70	37	30	24	19											

Model	Motor H.P.	Water depth in FEET capacity in GPM														Shut off head	
		P.S.I.	100	150	200	250	300	350	400	450	500	400	450	500	550	Feet	P.S.I.
4FP-35-50 18 Stages	5	30		47	44	40	35	29	22	14					570	247	
		40	49	46	42	38	33	26	19								
		50	47	44	40	35	29	22									
		60	46	42	38	33	26	19									
		70	44	40	35	29	21										
4FP-35-75 27 Stages	7 ½	30			50	47	45	43	40	38	34	32	26	21	15	859	359
		40			47	46	45	42	39	36	33	30	24	19	10		
		50		50	46	45	43	40	38	34	32	26	21	15			
		60		48	46	45	42	39	36	33	29	25	20	13			
		70	50	46	45	43	41	38	35	32	26	21	15				

Model	Motor H.P.	Water depth in FEET capacity in GPM														Shut off head	
		P.S.I.	200	300	400	500	600	700	800	900	1000					Feet	P.S.I.
4FP-35-100 36 Stages	10	20		50	45	43	39	34	28	20	10				1144	496	
		30	52	48	45	42	36	33	26	19							
		40	51	48	45	41	36	32	25	18							
		50	50	47	44	40	36	30	23	15							
		60	50	46	43	39	34	28	20								

Numbers in *italic-bold* indicate the maximum efficiency zone

To convert **feet** in **meters** multiply by 0.3048

To convert **U.S. gallon** in **Liters** multiply by 3.785

Pumping curves

FP series - 35 GPM

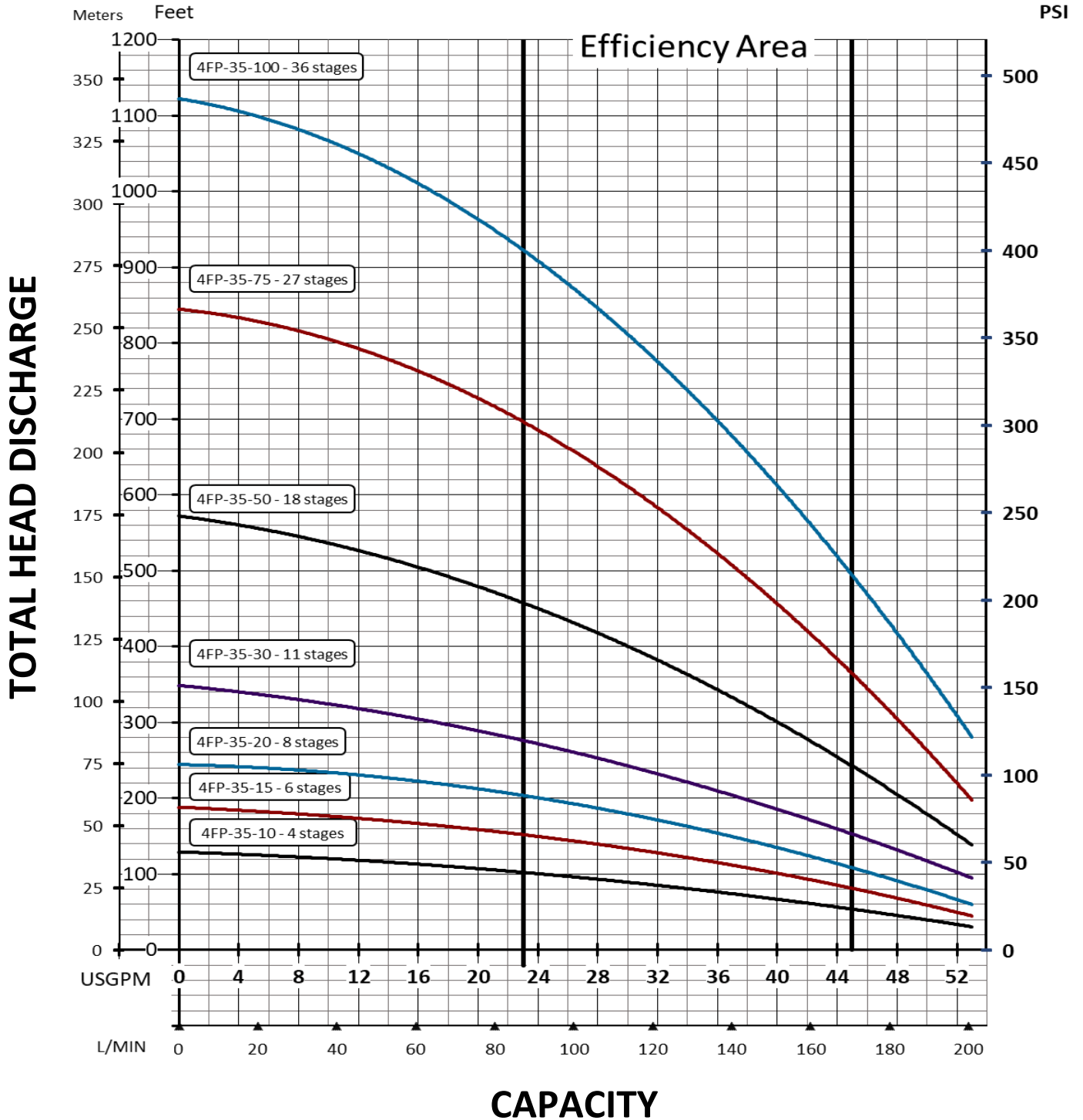



Performance charts

FP series - 50 GPM

Model	Motor H.P.	Water depth in FEET capacity in GPM													Shut off head	
		P.S.I.	20	40	60	80	100	120	140	160					Feet	P.S.I.
4 FP-50-15 4 Stages	1 ½	20	60	54	42	24									135	58
		30	53	39	19											
4 FP-50-20 5 Stages	2	30	66	60	52	49	35	18							167	72
		40	63	51	46	32	15									
		50	52	44	30											
4 FP-50-30 7 Stages	3	60	40	30											236	102
		30	68	63	60	55	49	43	33	17						
		40	61	59	54	47	42	30								
		50	56	52	46	40	29									
		60	53	45	37	25										

Model	Motor H.P.	Water depth in FEET capacity in GPM													Shut off head	
		P.S.I.	50	100	150	200	250	300	350	400	450	500	550	600	Feet	P.S.I.
4 FP-50-50 12 Stages	5	30		68	60	51	41	18							400	173
		40		64	56	47	36									
		50	68	60	51	41	18									
		60	64	56	47	36										
		70	60	51	41	25										
4 FP-50-75 17 Stages	7 ½	30			67	62	58	54	47	40	28				574	248
		40		69	65	60	56	51	45	35	18					
		50	71	67	62	58	54	48	40	28						
		60	70	65	61	56	51	45	36	19						
		70	69	64	59	54	49	41	30							
4 FP-50-100 23 Stages	10	30					65	61	59	55	52	47	41		780	338
		40					63	60	58	54	50	45	38			
		50				65	61	59	55	52	47	41	34			
		60				63	60	58	54	50	45	38	29			
		70			65	61	59	55	52	47	41	35	23			

Numbers in *italic-bold* indicate the maximum efficiency zone
 To convert **feet** in **meters** multiply by 0.3048
 To convert **U.S. gallon** in **Liters** multiply by 3.785

Pumping curves

FP series - 50 GPM

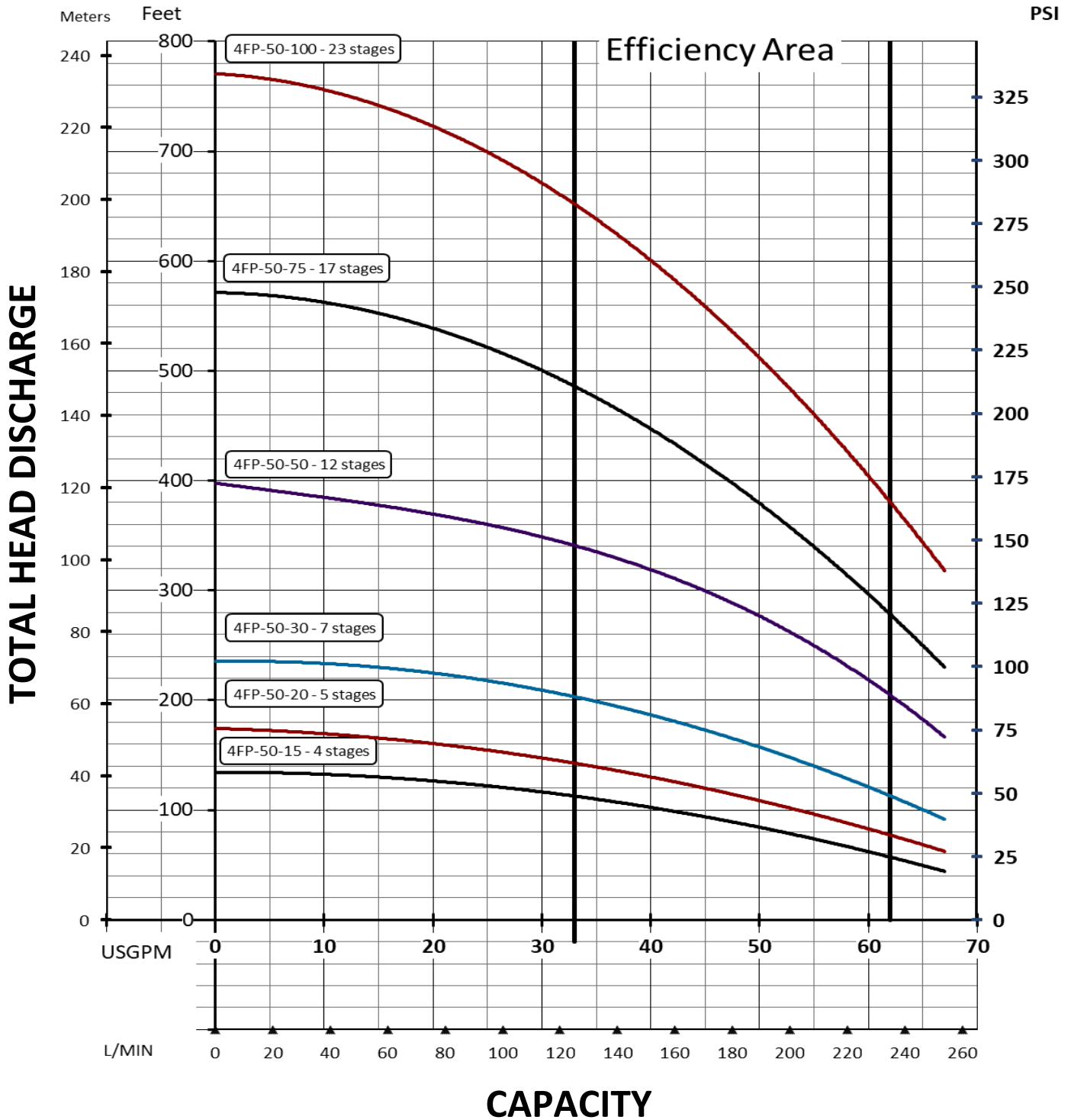



Performance charts

FP series - 80 GPM

Model	Motor H.P.	Water depth in FEET capacity in GPM														Shut off head	
		P.S.I.	20	30	40	50	60	70	80	90	100					Feet	P.S.I.
4 FP-80-20 4 Stages	2	20	76	64	55	41	27									128	55
		30	54	36	20												
		40	22														
4 FP-80-30 5 Stages	3	20	88	83	74	66	58	49	34						157	68	
		30	70	62	52	43											
		40	52	39	30												
4 FP-80-50 8 Stages	5	30	94	90	85	80	76	71	67	61	56				255	110	
		40	85	80	76	71	67	61	56	50	45						
		50	76	71	67	61	56	50	45	38							
		60	67	61	56	50	45	38									
		70	56	50	45	38											

Model	Motor H.P.	Water depth in FEET capacity in GPM														Shut off head	
		P.S.I.	50	75	100	125	150	175	200	225	250	275	300	350	400	Feet	P.S.I.
4 FP-80-75 13 Stages	7 ½	30	102	95	88	80	73	65	58	49	40	31				420	182
		40	96	89	82	75	66	58	50	41	32						
		50	85	78	69	62	54	45	37								
		60	82	75	66	58	50	41									
		70	76	68	60	50	44										
4 FP-80-100 17 Stages	10	30	113	108	102	95	90	83	77	70	64	58	50	43	38	540	234
		40	109	103	97	92	86	80	72	67	60	54	46	40			
		50	102	95	90	83	77	70	64	58	50	43	38				
		60	97	92	86	80	72	67	60	54	46	40					
		70	90	83	77	70	64	58	50	43	38						

Les chiffres en **italique-gras** indique la zone d'efficacité maximale
 Pour transformer les **pieds** en **mètres**: multiplier par 0.3048
 Pour transformer les **gallons U.S.** en **litres**: multiplier par 3.785

Pumping curves

FP series - 80 GPM

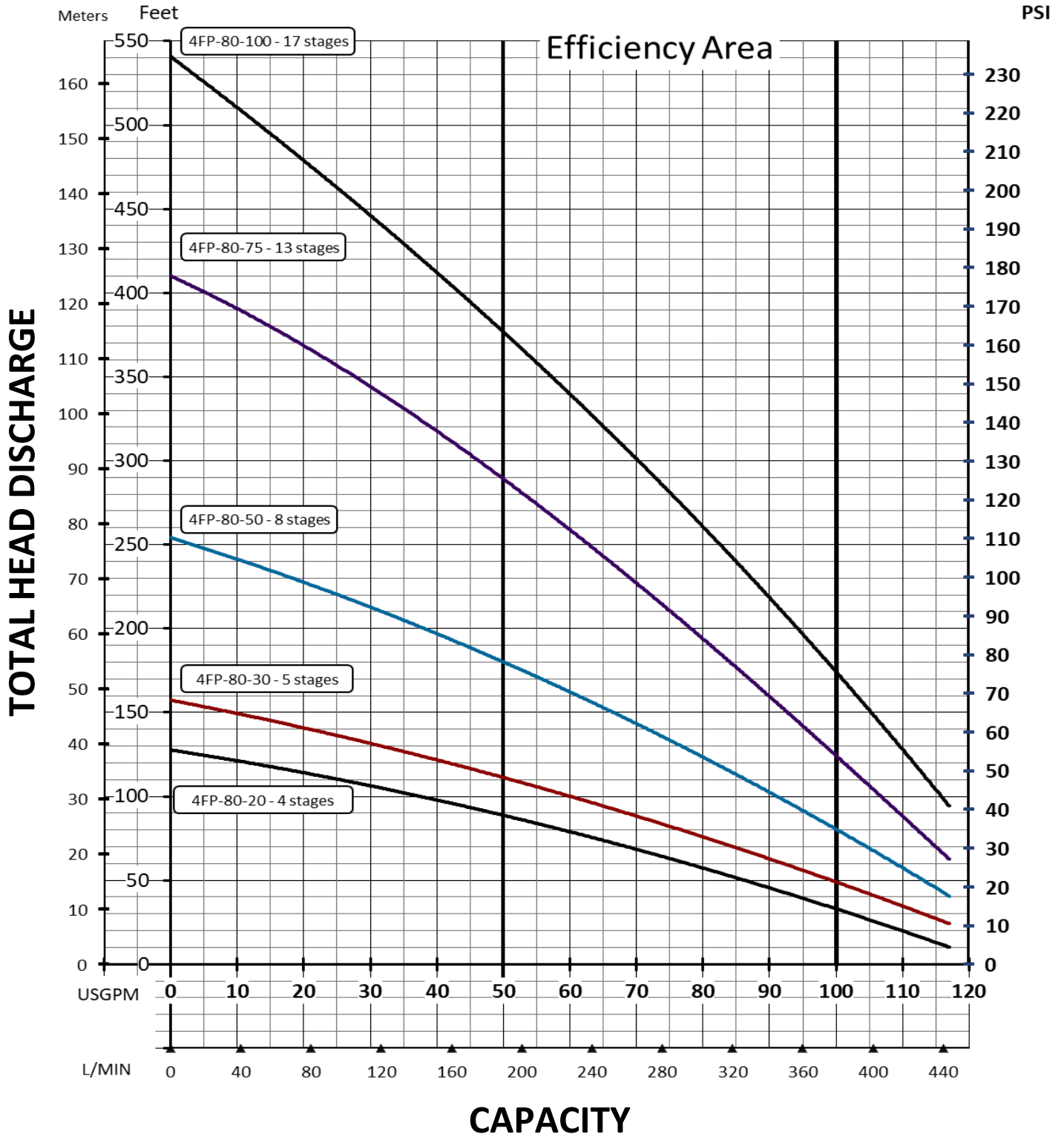

4" Submersible pump

FLS - 6 GPM Variable Speed



Pumping Curve FL6-ID
(at 80 Hz)

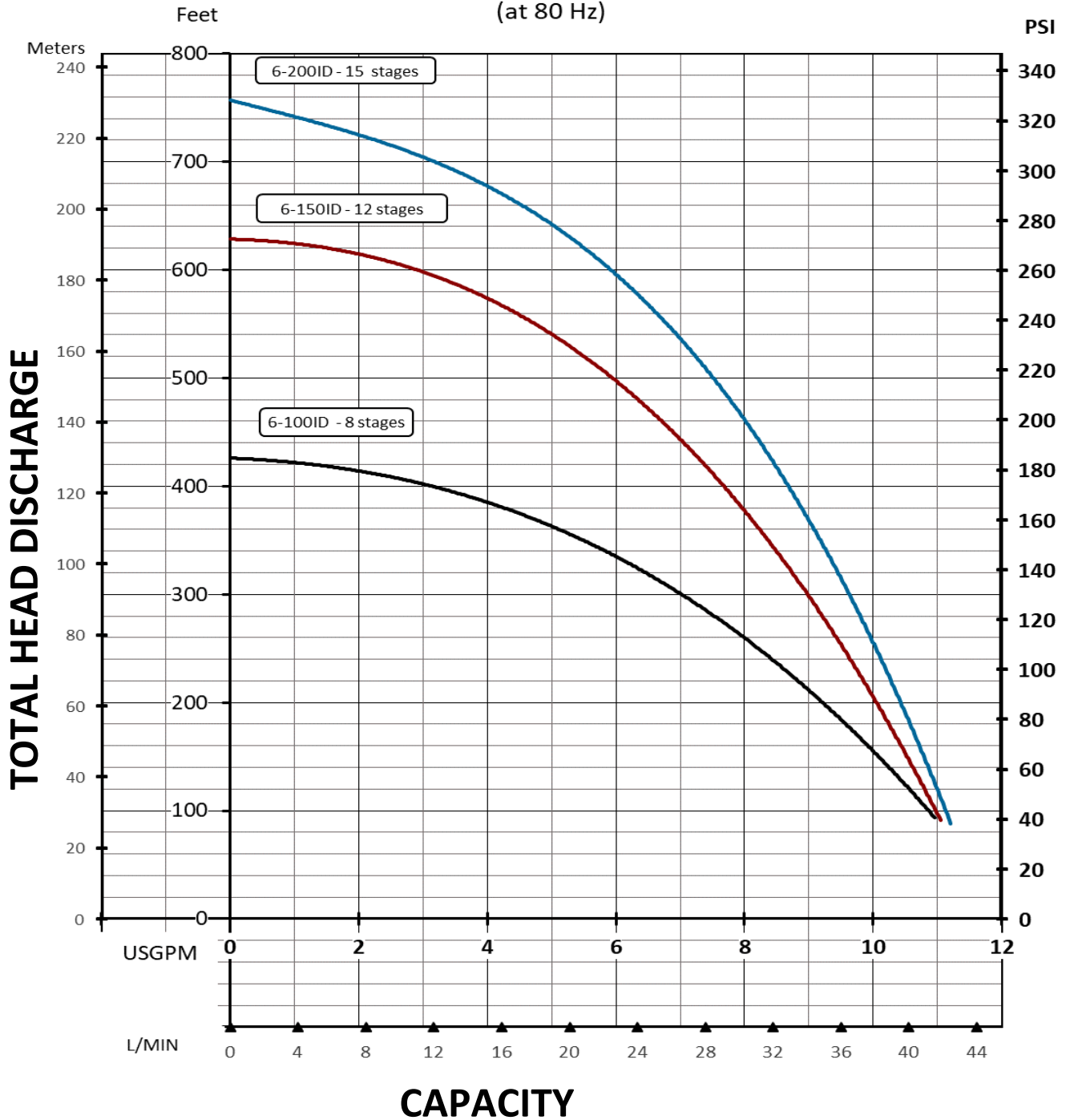



4" Submersible pump

FLS - 10 GPM Variable Speed

Pumping Curve FL10-ID
(at 80 Hz)

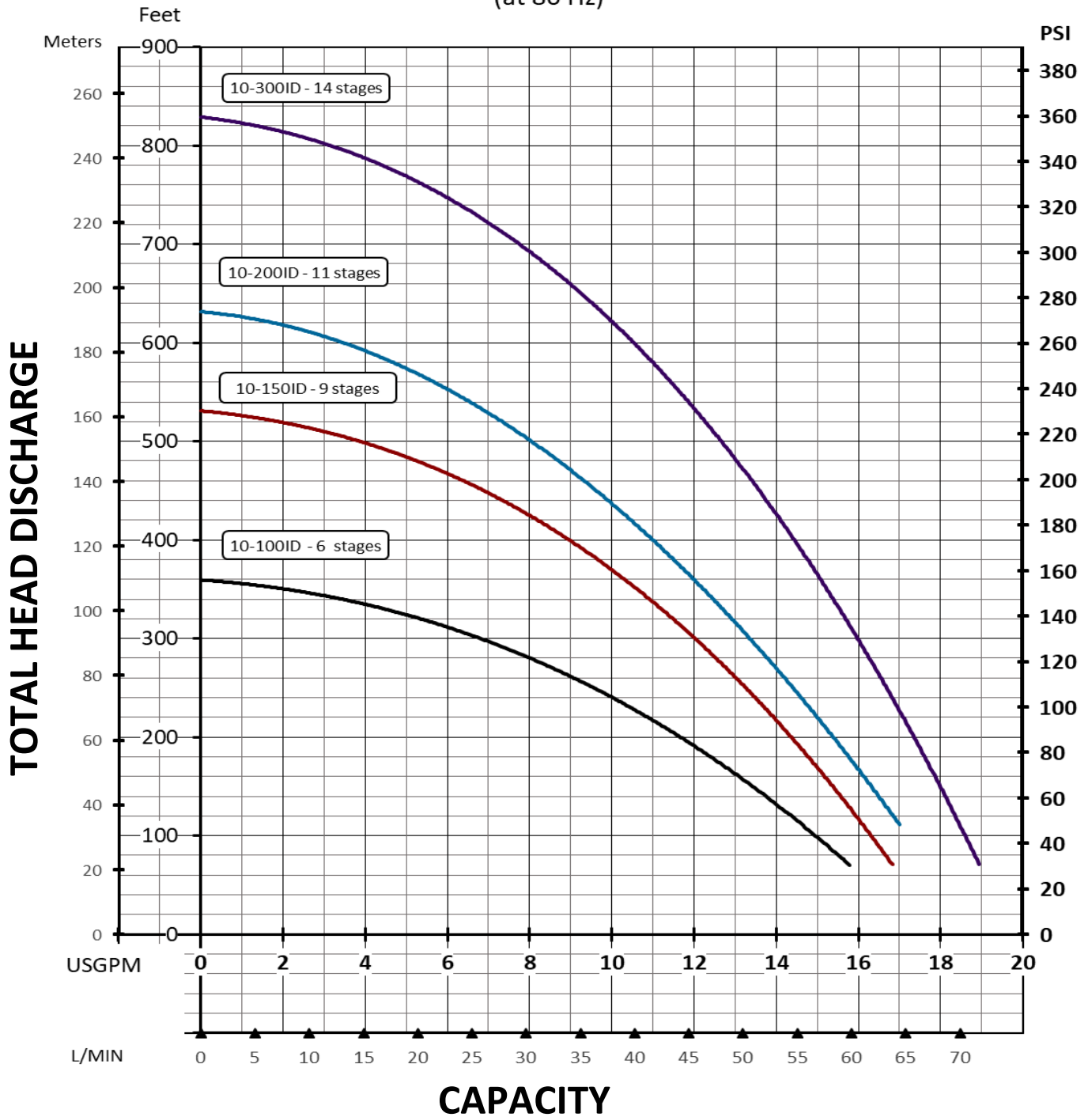

4" Submersible pump

FLS - 15 GPM Variable Speed



Pumping Curve FL15-ID
(at 80 Hz)

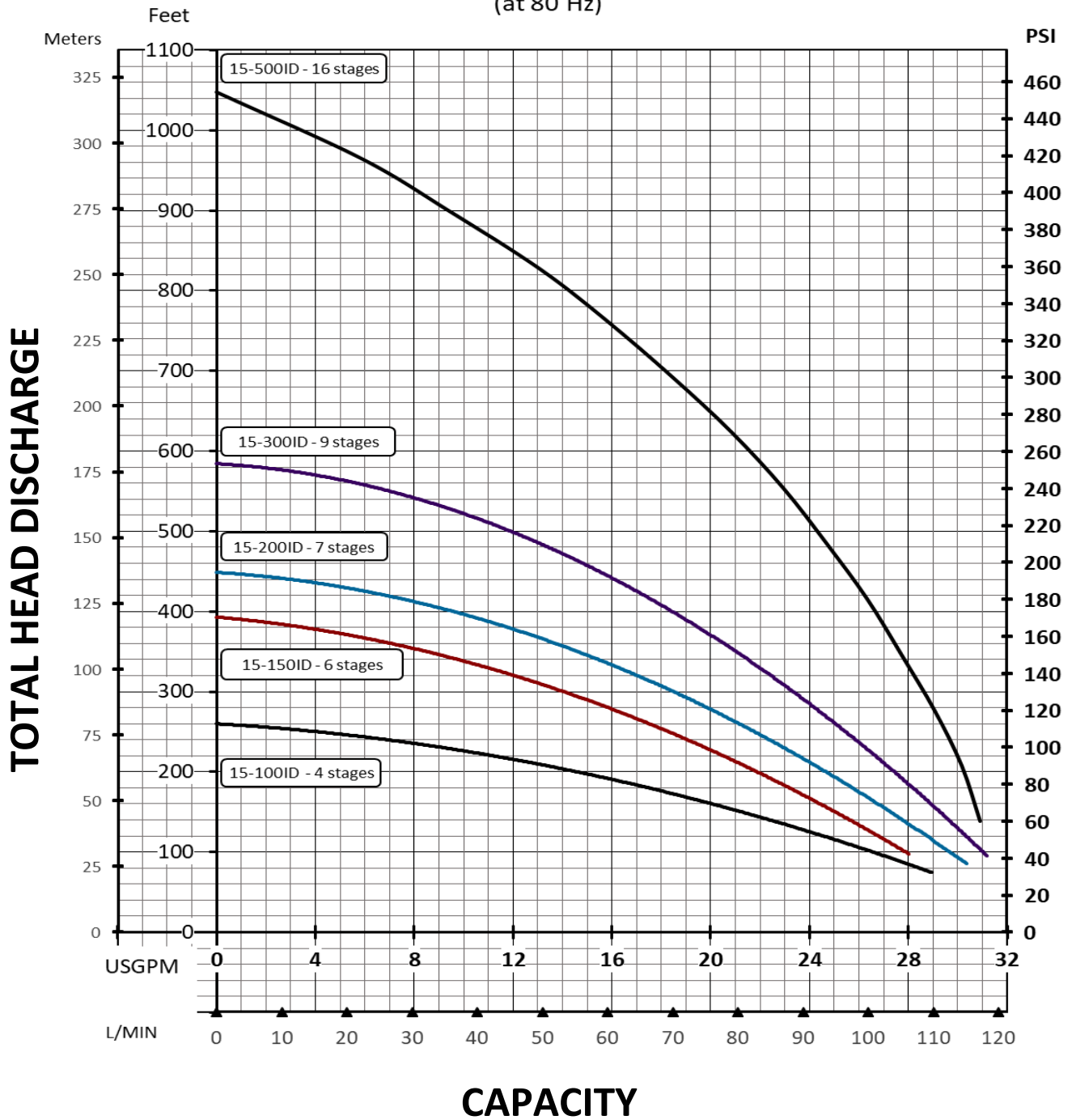



4" Submersible pump

FLS - 25 GPM Variable Speed

Pumping Curve FL25-ID
(at 80 Hz)

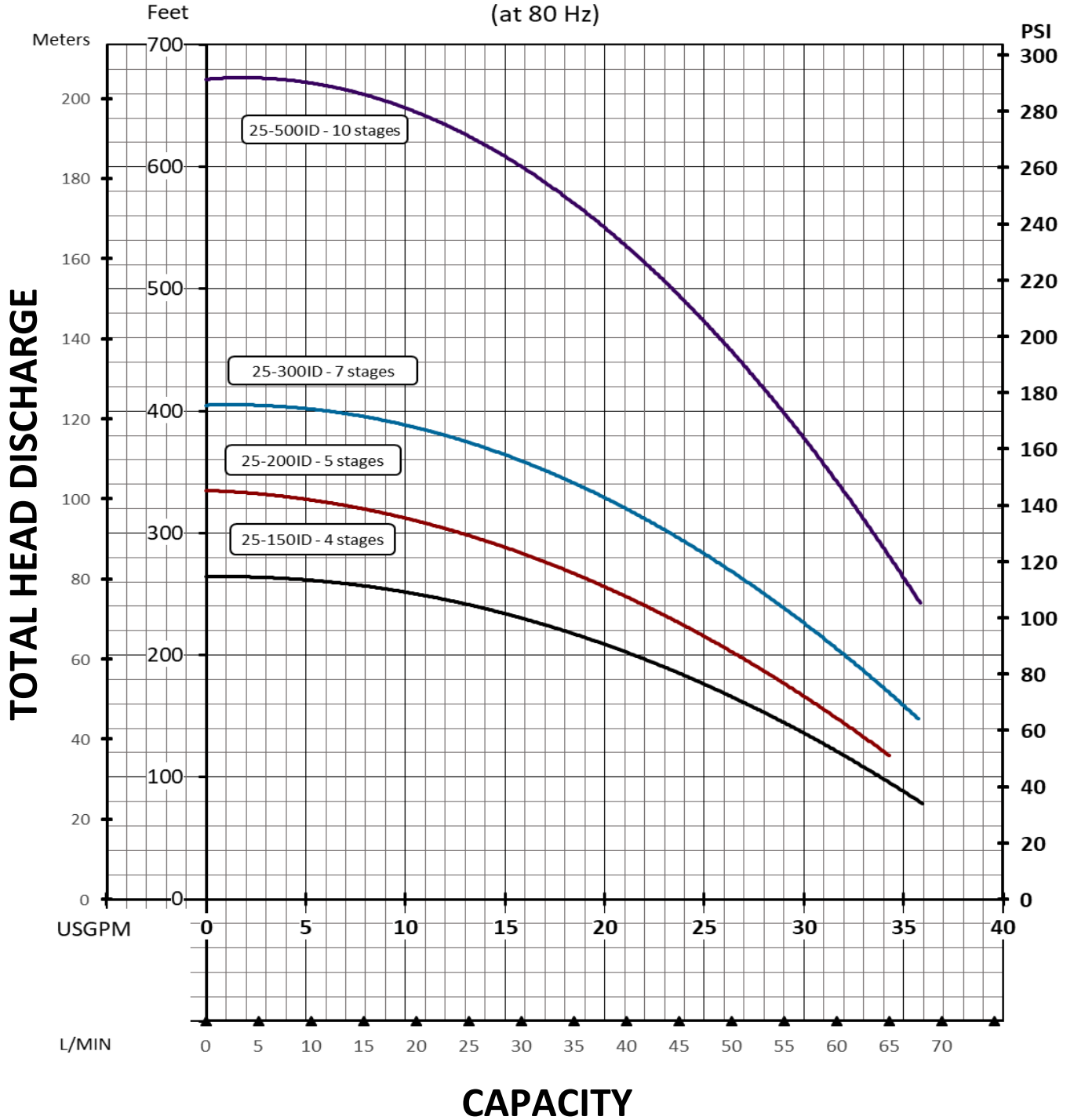



Pumping curves 6"

AP series - 50 GPM

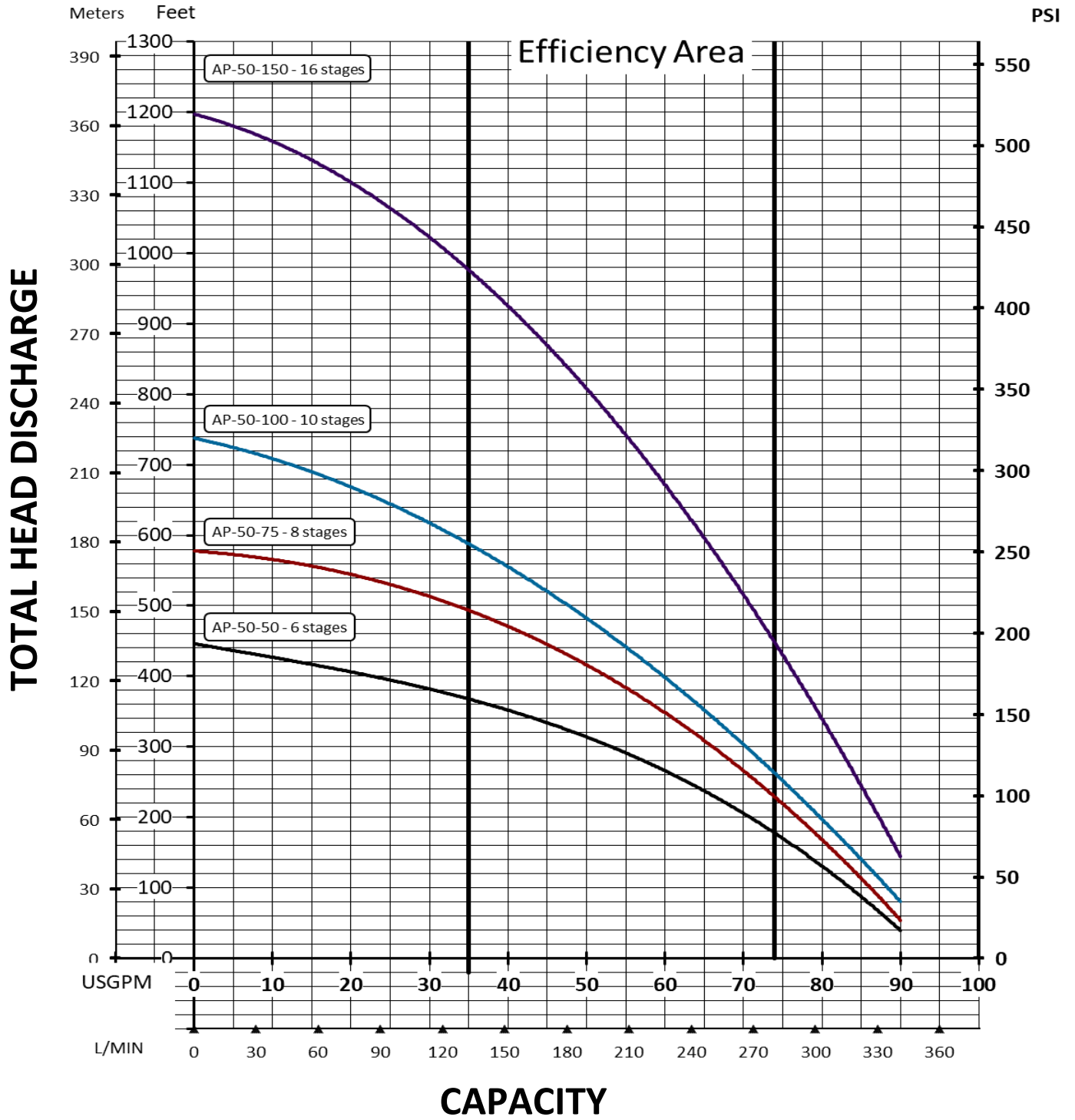

Pumping curves 6"

AP series - 75 GPM

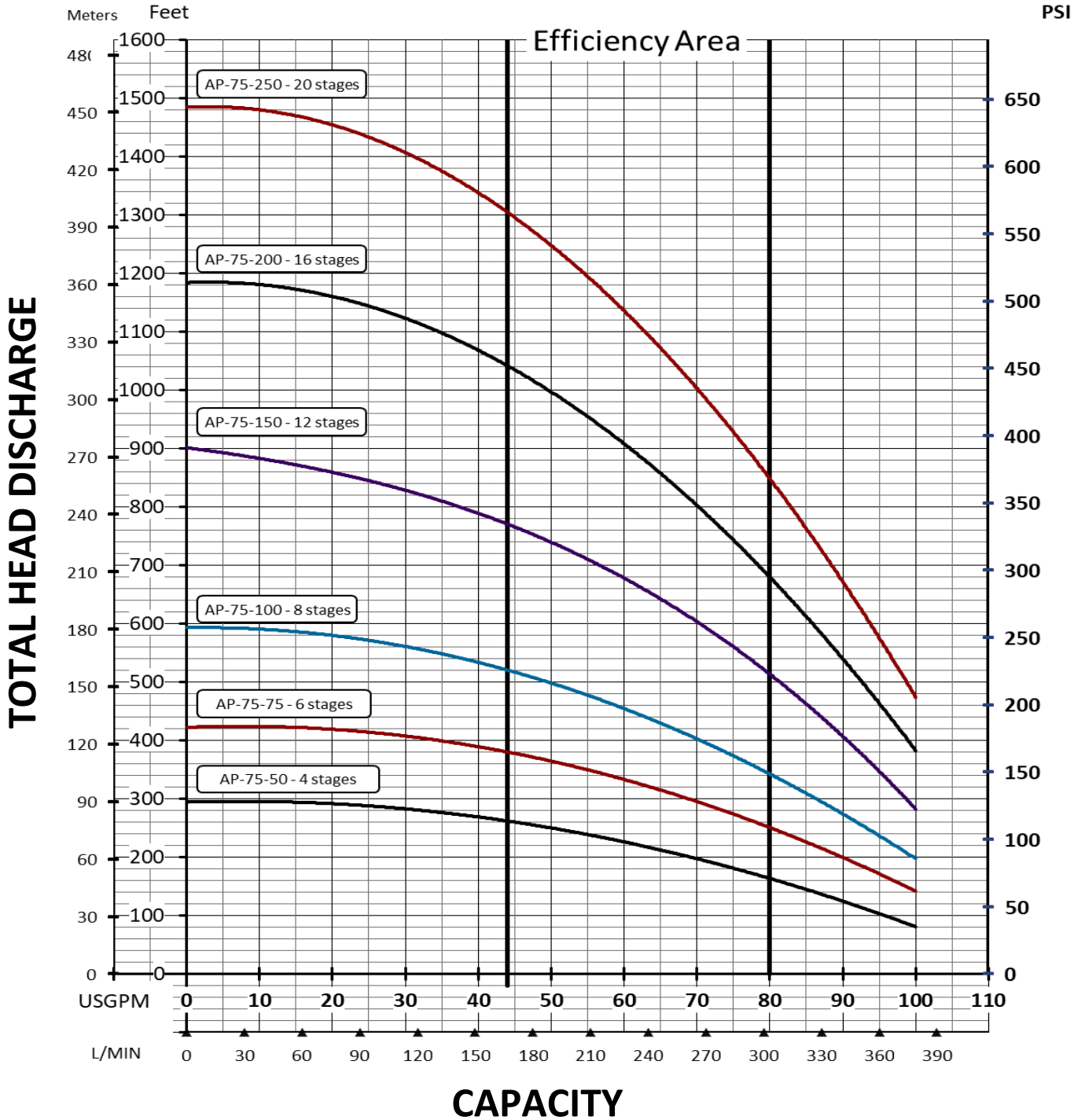



Pumping curves 6"

AP series - 120 GPM

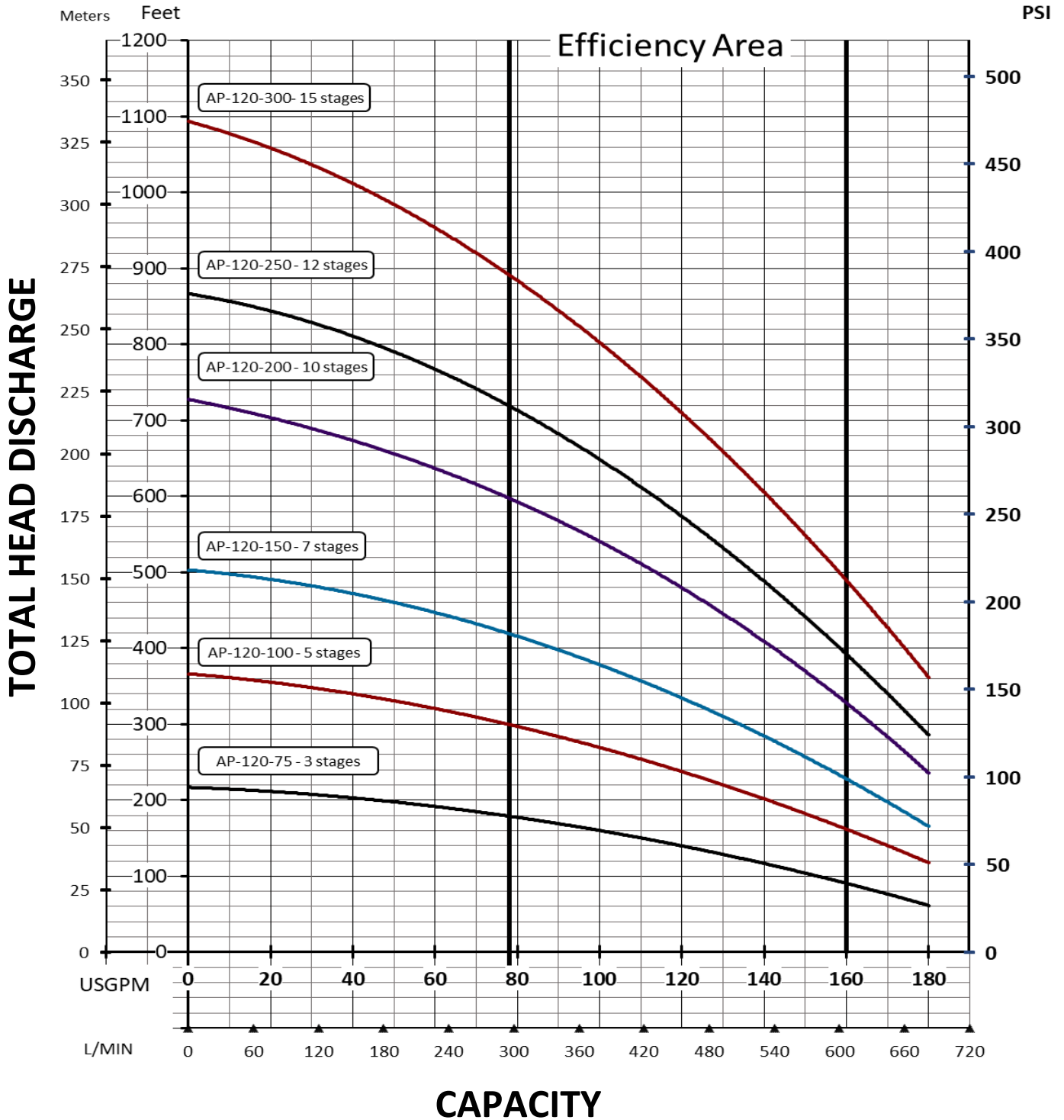

Pumping curves 6"

AP-series - 170 GPM

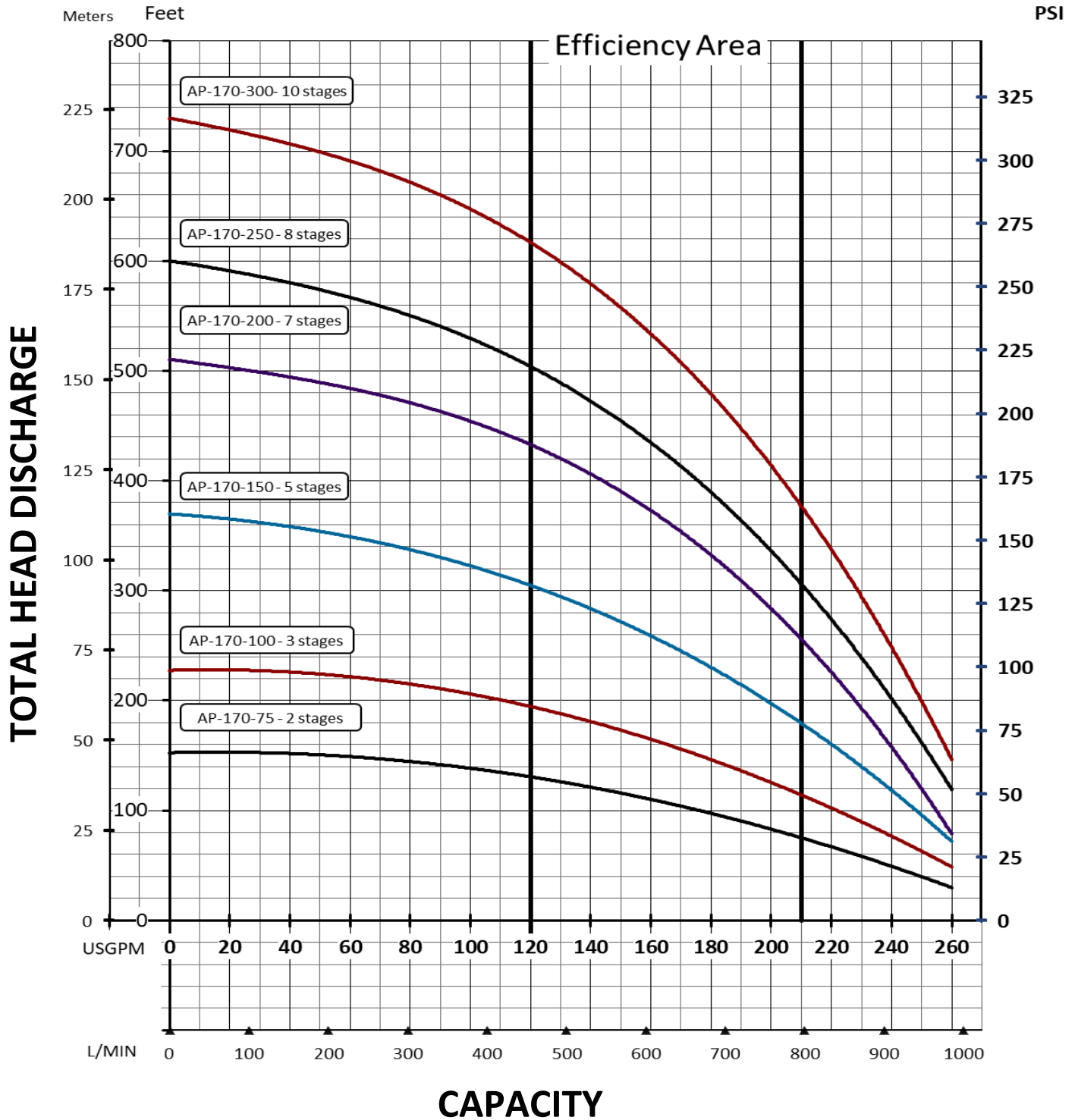



Pumping curves 6"

AP series - 230 GPM

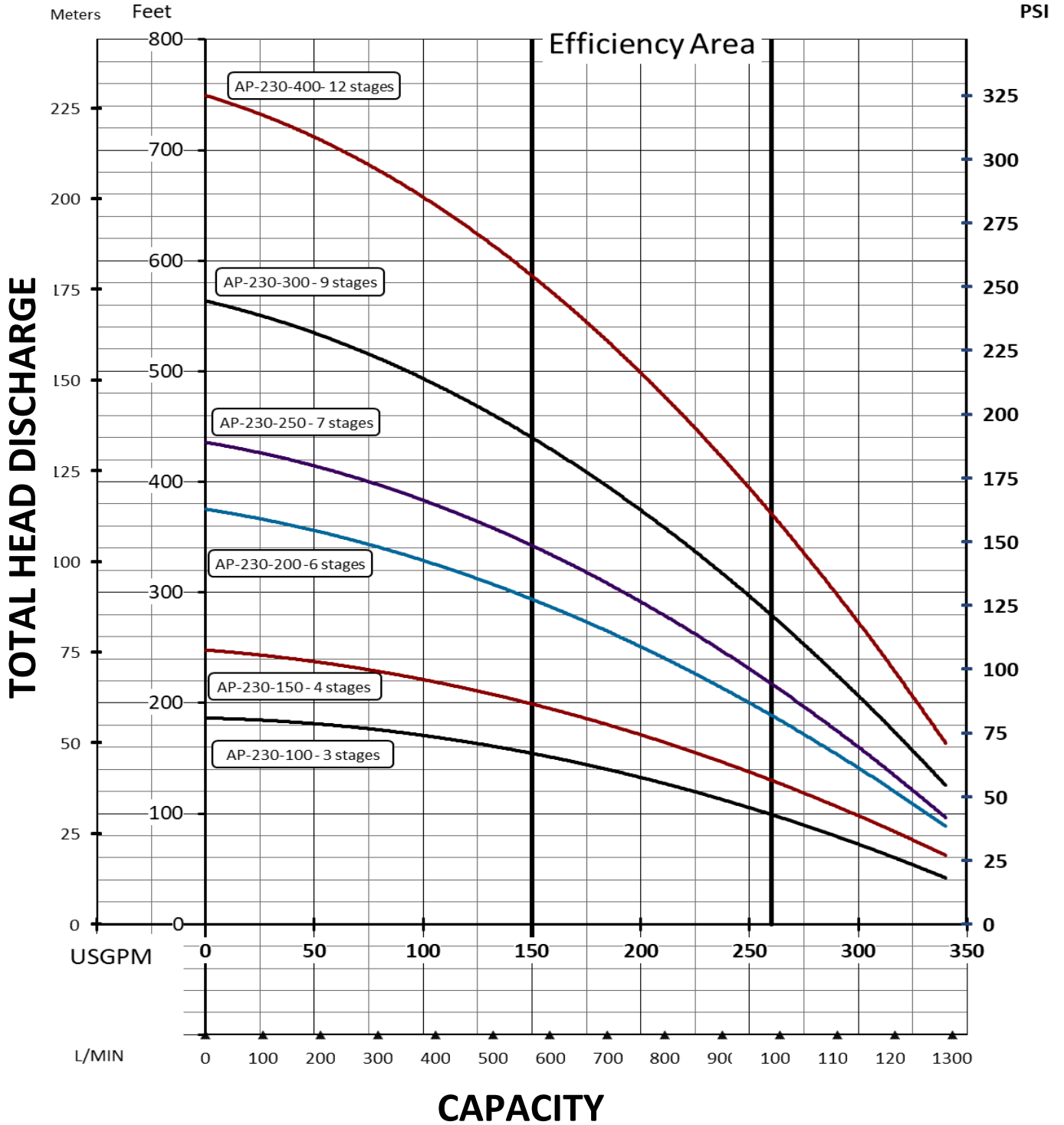

Submersible motors



4" - 2 WIRES + GROUND - 60 Hz

Part number	H.P.	kW	Volts	Ph.	Length "L" In (cm)	Weight kg (lb)	Suggested list price
153-0100	1/2	.37	115	1	11 (27.9)	19 (8.7)	730,00 \$ *
153-0120	1/2	.37	230	1	11 (27.9)	19 (8.7)	693,00 \$ *
153-0140	3/4	.55	230	1	12.4 (31.4)	23 (10.3)	840,00 \$ *
153-0160	1	.75	230	1	13.3 (33.7)	24 (11.1)	1 050,00 \$ *
153-0180	1 ½	1.1	230	1	14.9 (37.8)	29 (13.1)	1 308,00 \$ *

*see net price list

4" - 3 WIRES + GROUND - 60 Hz

Part number	H.P.	kW	Volts	Ph.	Length "L" In (cm)	Weight kg (lb)	Suggested list price
153-0240	1/2	.37	115	1	10 (25.3)	19 (8.6)	624,00 \$ *
153-0260	1/2	.37	230	1	9.7 (24.6)	18 (8.2)	567,00 \$ *
153-0280	3/4	.56	230	1	10.8 (27.5)	21 (9.7)	684,00 \$ *
153-0300	1	.75	230	1	11.7 (29.7)	23 (10.5)	723,00 \$ *
153-0320	1 ½	1.1	230	1	13.6 (34.5)	27 (12.4)	1 052,00 \$ *
153-0325	1 ½	1.1	230	3	11.7 (29.7)	23 (10.5)	1 034,00 \$ *
153-0340	1 ½	1.1	575	3	11.7 (29.7)	23 (10.5)	1 034,00 \$ *
153-0360	2	1.5	230	1	15.1 (38.3)	31 (14.1)	1 332,00 \$ *
153-0380	2	1.5	575	3	13.8 (35.1)	27 (12.4)	1 158,00 \$ *
153-0400	3	2.2	230	1	18.3 (46.6)	40 (18.1)	2 097,00 \$ *
153-0407	3	2.2	230	3	15.3 (38.9)	32 (14.5)	1 672,00 \$ *
153-0420	3	2.2	575	3	15.3 (38.9)	32 (14.5)	1 672,00 \$ *
153-0440	5	3.7	230	1	27.7 (70.3)	70 (31.8)	2 914,00 \$ *
153-0460	5	3.7	575	3	21.7 (55.0)	55 (24.9)	2 633,00 \$ *
153-0470	7.5	5.6	230	3	27.7 (70.3)	70 (31.8)	3 284,00 \$ *
153-0480	7.5	5.6	575	3	27.7 (70.3)	70 (31.8)	3 284,00 \$ *

*see net price list



MOTOR LEADS

Part number	Number of wires	Type of connection	Length In (cm)	Type of motor	Suggested list price
153-0720	3 + gr	Single	48 (121.9)	4 inches	95,00 \$
153-0760	2 + gr	Single	48 (121.9)	4 inches	95,00 \$

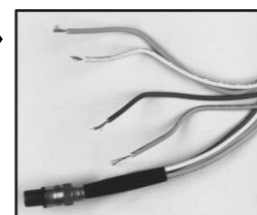

Other voltage available 208, 460 Volts. - 3 phases.
Please indicate the required voltage on your order



Control boxes and electronic controls

CONTROL BOXES for submersible 3 wires motors + ground - (1 phase)

Part number	H.P.	kW	Volts	Maximum size of wire	Shipping weight lbs (Kg)	Suggested list price
Capacitor Start Induction Run (CSIR)						
153-0520	1/2	.37	115	#10 AWG	3.05 (1.38)	136,00 \$ *
153-0540	1/2	.37	230	#10 AWG	3.05 (1.38)	130,00 \$ *
153-0560	3/4	.55	230	#10 AWG	3.05 (1.38)	139,00 \$ *
153-0580	1	.75	230	#10 AWG	3.05 (1.38)	146,00 \$ *
Capacitor Start Capacitor Run (CSCR)						
153-0585	1/2	.37	230	#10 AWG	3.05 (1.38)	199,00 \$ *
153-0590	3/4	.55	230	#10 AWG	3.05 (1.38)	207,00 \$ *
153-0595	1	.75	230	#10 AWG	3.05 (1.38)	230,00 \$ *
153-0600	1 1/2	1.1	230	#2 AWG	6.63 (3.00)	246,00 \$ *
153-0620	2	1.5	230	#2 AWG	6.63 (3.00)	401,00 \$ *
153-0640	3	2.2	230	#2 AWG	6.63 (3.00)	492,00 \$ *
153-0660	5	3.7	230	#2 AWG	6.63 (3.00)	703,00 \$ *

* see net price list



ELECTRONIC CONTROLS

SPP-231 // SPP-111

PROTECTS AGAINST:

- Low yield wells
- Low voltage
- Air or gas locked pump
- Drop in water level
- Broken shaft or coupling
- Worn pump parts
- Can be adjusted from 2 to 90 minutes



#153-2010 // #153-2002

SPP-233-1.5 // SPP-233 // SPP-111-3RL

PROTECTS AGAINST:

- Low yield wells
- Over / under voltage
- Overload
- Mud or sand clogging
- Air or gas locked pump
- Drop in water level
- Rapid cycling
- Faulty check valve
- Can be adjusted from 2 to 90 minutes



#153-2000 // #153-2005 // #153-2015

Part number	Model	Voltage	Motors	Suggested list price
153-2000	SPP-233-1.5	230	1/2 – 1 1/2 HP	506,00 \$ *
153-2002	SPP-111	115	1/3 – 1/2 HP	344,00 \$ *
153-2005	SPP-233	230	1/2 – 3 HP	769,00 \$ *
153-2010	SPP-231	230	1/2 – 1 HP	409,00 \$ *
153-2015	SPP-111-3RL	115	1/3 – 1 HP	394,00 \$ *

* see net price list

Compatible with 4" Pentek motors

Booster pump PXP



New

Discover the extreme pressure of
the PXP pump (Pompcos Extreme Pressure)

Up to 520 P.S.I.



Extreme water pressure requires a pump with long lasting strength & durability.

PXP pumps are the result from hours of research & development offering you a range of flows at high pressure combining reliable performance & longevity.

PXP by Pompcos is designed for tough agricultural, sugar bush, golf course & various applications that require continuous duty at extreme pressure.





Booster pump PXP

H.P.	GPM	Stages	Model	PUMP ONLY		ODP 1 PH		TEFC 1 PH	
				Part number	Suggested list price	Part number	Suggested list price	Part number	Suggested list price
1/2	6	9	PXP-6-50	650-0010	973,00 \$	650-2010	1 429,00 \$	650-3010	1 568,00 \$
	10	7	PXP-10-50	650-0210	923,00 \$	650-2210	1 384,00 \$	650-3210	1 524,00 \$
3/4	6	14	PXP-6-75	650-0020	1 082,00 \$	650-2020	1 622,00 \$	650-3020	1 750,00 \$
	10	11	PXP-10-75	650-0220	1 006,00 \$	650-2220	1 553,00 \$	650-3220	1 682,00 \$
	15	6	PXP-15-75	650-0420	907,00 \$	650-2420	1 466,00 \$	650-3420	1 656,00 \$
1	6	16	PXP-6-100	650-0030	1 126,00 \$	650-2030	1 740,00 \$	650-3030	1 903,00 \$
	10	13	PXP-10-100	650-0230	1 048,00 \$	650-2230	1 671,00 \$	650-3230	1 834,00 \$
	15	8	PXP-15-100	650-0430	952,00 \$	650-2430	1 585,00 \$	650-3430	1 814,00 \$
	25	5	PXP-25-100	650-0630	893,00 \$	650-2630	1 591,00 \$	650-3630	1 759,00 \$
1 1/2	6	22	PXP-6-150	650-0040	1 273,00 \$	650-2040	2 004,00 \$	650-3040	2 166,00 \$
	10	16	PXP-10-150	650-0240	1 110,00 \$	650-2240	1 852,00 \$	650-3240	2 013,00 \$
	15	11	PXP-15-150	650-0440	1 020,00 \$	650-2440	1 771,00 \$	650-3440	2 005,00 \$
	25	7	PXP-25-150	650-0640	938,00 \$	650-2640	1 764,00 \$	650-3640	1 930,00 \$
	35	5	PXP-35-150	650-0740	1 131,00 \$	650-2740	3 240,00 \$	650-3740	1 825,00 \$
2	10	21	PXP-10-200	650-0250	1 217,00 \$	650-2250	2 068,00 \$	650-3250	2 251,00 \$
	15	14	PXP-15-200	650-0450	1 086,00 \$	650-2450	1 952,00 \$	650-3450	2 174,00 \$
	25	9	PXP-25-200	650-0650	984,00 \$	650-2650	1 924,00 \$	650-3650	2 072,00 \$
	35	6	PXP-35-200	650-0750	1 202,00 \$	650-2750	2 438,00 \$	650-3750	1 954,00 \$
	50	4	PXP-50-200	650-0850	1 080,00 \$	650-2850	2 259,00 \$	650-3850	1 732,00 \$
3	10	31	PXP-10-300	650-0260	1 462,00 \$	650-2260	2 729,00 \$	650-3260	2 701,00 \$
	15	20	PXP-15-300	650-0460	1 256,00 \$	650-2460	2 547,00 \$	650-3460	2 462,00 \$
	25	13	PXP-25-300	650-0660	1 079,00 \$	650-2660	2 481,00 \$	650-3660	2 300,00 \$
	35	9	PXP-35-300	650-0760	1 355,00 \$	650-2760	2 438,00 \$	650-3760	2 200,00 \$
	50	6	PXP-50-300	650-0860	1 163,00 \$	650-2860	2 259,00 \$	650-3860	2 117,00 \$
	80	4	PXP-80-300	650-0960	1 100,00 \$	650-2960	2 196,00 \$	650-3960	2 056,00 \$
5	15	31	PXP-15-500	650-0470	1 427,00 \$	650-2470	3 340,00 \$		
	25	19	PXP-25-500	650-0670	1 257,00 \$	650-2670	3 240,00 \$		
	35	12	PXP-35-500	650-0770	1 776,00 \$	650-2770	3 940,00 \$		
	50	8	PXP-50-500	650-0870	1 615,00 \$	650-2870	3 792,00 \$		
	80	6	PXP-80-500	650-0970	1 541,00 \$	650-2970	3 721,00 \$		

EXAMPLE OF MODEL NUMBER

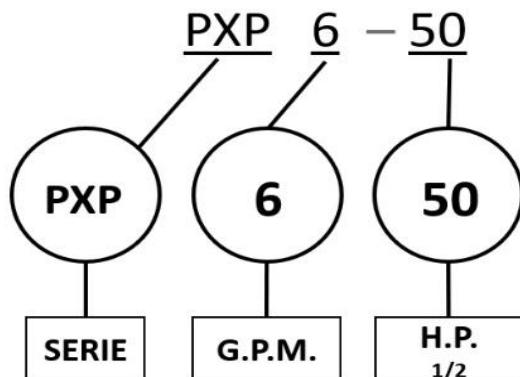

PUMP:

- Stainless steel pump head and motor
- In: 6-10-15-25 GPM = 1 1/4"
- In: 35-50-80 GPM = 1 1/2"
- Out: 1 1/4"

MOTOR:

- Motor 1/2 H.P. à 2 H.P. - 115/230 Volts - 1 Phase - OPD
- Motor 3 & 5 H.P. - 230 Volts - 1 Phase - OPD

*Other voltage and TEFC motors available as options

Booster pump PXP



H.P.	GPM	Stages	Model	ODP 3 PH 575V		TEFC 3 PH 575V		ODP 3 PH 230V		TEFC 3 PH 230V	
				Part number	Suggested list price	Part number	Suggested list price	Part number	Suggested list price	Part number	Suggested list price
1/2	6	9	PXP-6-50	650-5010	1 625,00 \$	650-6010	1 789,00 \$	650-8010	1 656,00 \$	650-9010	1 825,00 \$
	10	7	PXP-10-50	650-5210	1 579,00 \$	650-6210	1 744,00 \$	650-8210	1 608,00 \$	650-9210	1 778,00 \$
3/4	6	14	PXP-6-75	650-5020	1 917,00 \$	650-6020	1 910,00 \$	650-8020	1 956,00 \$	650-9020	2 118,00 \$
	10	11	PXP-10-75	650-5220	1 846,00 \$	650-6220	1 839,00 \$	650-8220	1 884,00 \$	650-9220	2 046,00 \$
	15	6	PXP-15-75	650-5420	1 758,00 \$	650-6420	1 749,00 \$	650-8420	1 791,00 \$	650-9420	1 956,00 \$
1	6	16	PXP-6-100	650-5030	2 104,00 \$	650-6030	2 308,00 \$	650-8030	2 145,00 \$	650-9030	2 353,00 \$
	10	13	PXP-10-100	650-5230	2 033,00 \$	650-6230	2 236,00 \$	650-8230	2 072,00 \$	650-9230	2 280,00 \$
	15	8	PXP-15-100	650-5430	1 945,00 \$	650-6430	2 148,00 \$	650-8430	1 984,00 \$	650-9430	2 190,00 \$
	25	5	PXP-25-100	650-5630	1 889,00 \$	650-6630	2 093,00 \$	650-8630	1 926,00 \$	650-9630	2 134,00 \$
1 1/2	6	22	PXP-6-150	650-5040	2 045,00 \$	650-6040	2 376,00 \$	650-8040	2 394,00 \$	650-9040	2 606,00 \$
	10	16	PXP-10-150	650-5240	1 887,00 \$	650-6240	2 217,00 \$	650-8240	2 233,00 \$	650-9240	2 441,00 \$
	15	11	PXP-15-150	650-5440	1 803,00 \$	650-6440	2 132,00 \$	650-8440	2 146,00 \$	650-9440	2 358,00 \$
	25	7	PXP-25-150	650-5640	1 729,00 \$	650-6640	2 059,00 \$	650-8640	2 071,00 \$	650-9640	2 282,00 \$
	35	5	PXP-35-150	650-5740	1 599,00 \$	650-6740	1 901,00 \$	650-8740	2 057,00 \$	650-9740	2 253,00 \$
2	10	21	PXP-10-200	650-5250	2 196,00 \$	650-6250	2 462,00 \$	650-8250	2 537,00 \$	650-9250	2 789,00 \$
	15	14	PXP-15-200	650-5450	2 074,00 \$	650-6450	2 342,00 \$	650-8450	2 416,00 \$	650-9450	2 666,00 \$
	25	9	PXP-25-200	650-5650	1 973,00 \$	650-6650	2 241,00 \$	650-8650	2 311,00 \$	650-9650	2 564,00 \$
	35	6	PXP-35-200	650-5750	1 857,00 \$	650-6750	2 088,00 \$	650-8750	2 282,00 \$	650-9750	2 535,00 \$
	50	4	PXP-50-200	650-5850	1 812,00 \$	650-6850	2 040,00 \$	650-8850	2 217,00 \$	650-9850	2 467,00 \$
3	10	31	PXP-10-300	650-5260	2 572,00 \$	650-6260	2 893,00 \$	650-8260	3 201,00 \$	650-9260	3 529,00 \$
	15	20	PXP-15-300	650-5460	2 643,00 \$	650-6460	2 702,00 \$	650-8460	3 007,00 \$	650-9460	3 337,00 \$
	25	13	PXP-25-300	650-5660	2 221,00 \$	650-6660	2 541,00 \$	650-8660	2 843,00 \$	650-9660	3 171,00 \$
	35	9	PXP-35-300	650-5760	2 100,00 \$	650-6760	2 161,00 \$	650-8760	2 811,00 \$	650-9760	3 138,00 \$
	50	6	PXP-50-300	650-5860	2 020,00 \$	650-6860	2 073,00 \$	650-8860	2 714,00 \$	650-9860	3 042,00 \$
	80	4	PXP-80-300	650-5960	1 959,00 \$	650-6960	2 018,00 \$	650-8960	2 675,00 \$	650-9960	3 004,00 \$
5	15	31	PXP-15-500	650-5470	7 199,00 \$						
	25	19	PXP-25-500	650-5670	6 963,00 \$						
	35	12	PXP-35-500	650-5770	6 919,00 \$						
	50	8	PXP-50-500	650-5870	6 719,00 \$						
	80	6	PXP-80-500	650-5970	6 663,00 \$						

ROTATING KIT				
H.P.	G.P.M.	STAGES	Part number	Suggested list price
1/2	6	9	651-0010	305,00 \$
	10	7	651-0210	257,00 \$
3/4	6	14	651-0020	403,00 \$
	10	11	651-0220	333,00 \$
	15	6	651-0420	236,00 \$
1	6	16	651-0030	444,00 \$
	10	13	651-0230	370,00 \$
	15	8	651-0430	272,00 \$
	25	5	651-0630	225,00 \$
1 1/2	6	22	651-0040	562,00 \$
	10	16	651-0240	426,00 \$
	15	11	651-0440	327,00 \$
	25	7	651-0640	264,00 \$
2	10	21	651-0250	518,00 \$
	15	14	651-0450	382,00 \$
	25	9	651-0650	303,00 \$
3	10	31	651-0260	719,00 \$
	15	2	651-0460	506,00 \$
	25	13	651-0660	382,00 \$
5	15	31	651-0470	707,00 \$
	25	19	651-0670	514,00 \$



Pumping curves PXP

PXP 6 GPM

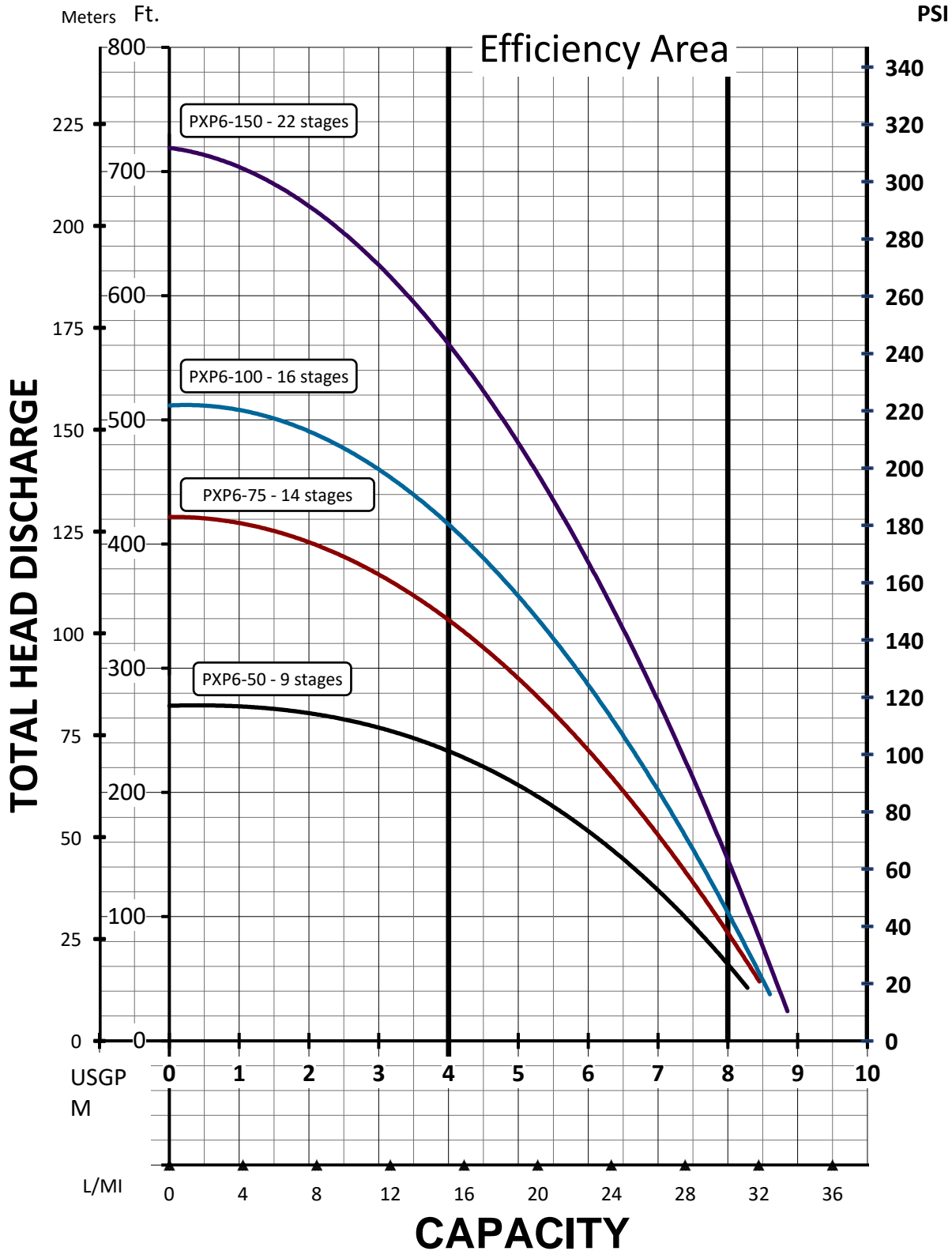

Pumping curves PXP

PXP 10 GPM

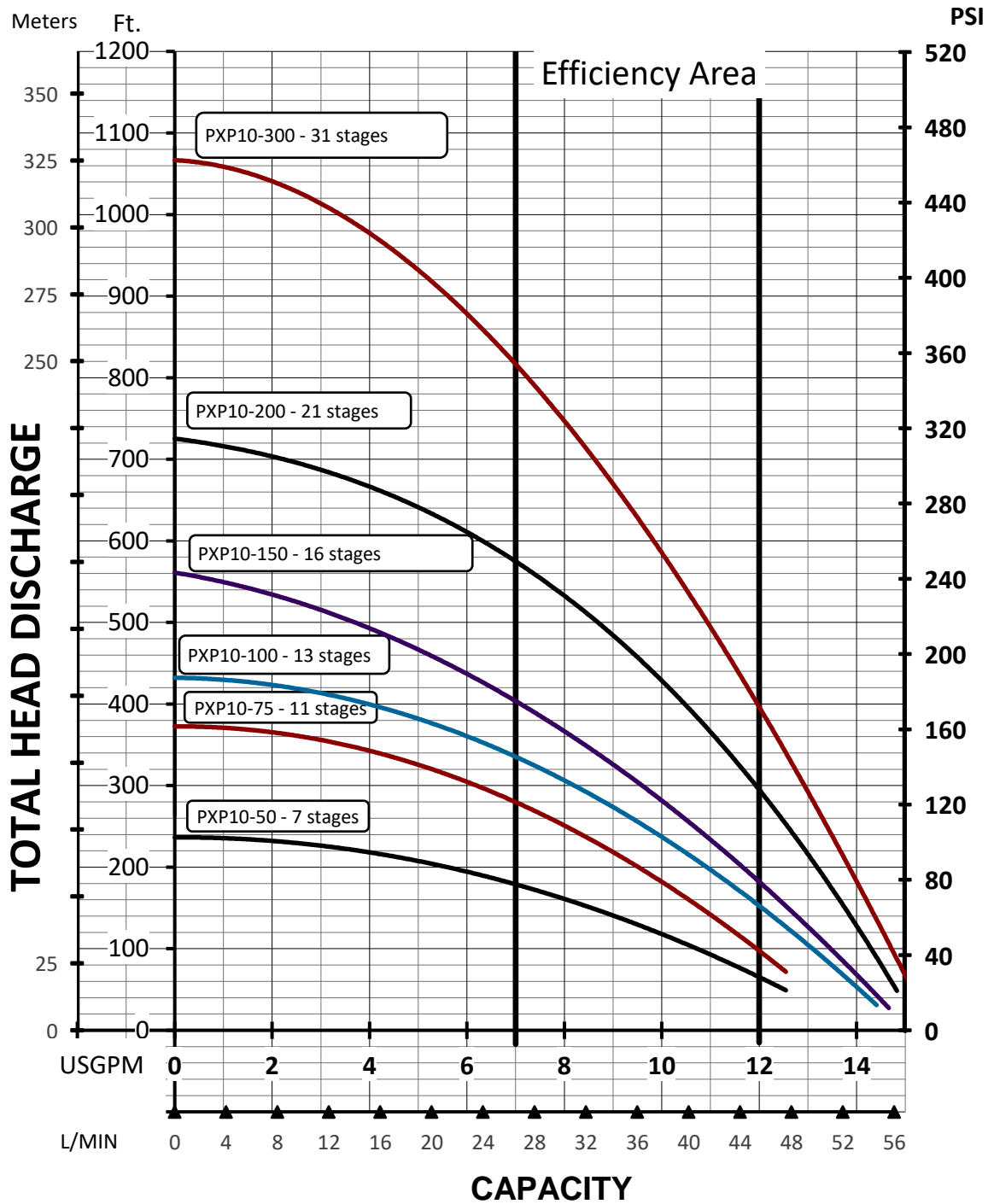



Pumping curves PXP

PXP 15 GPM

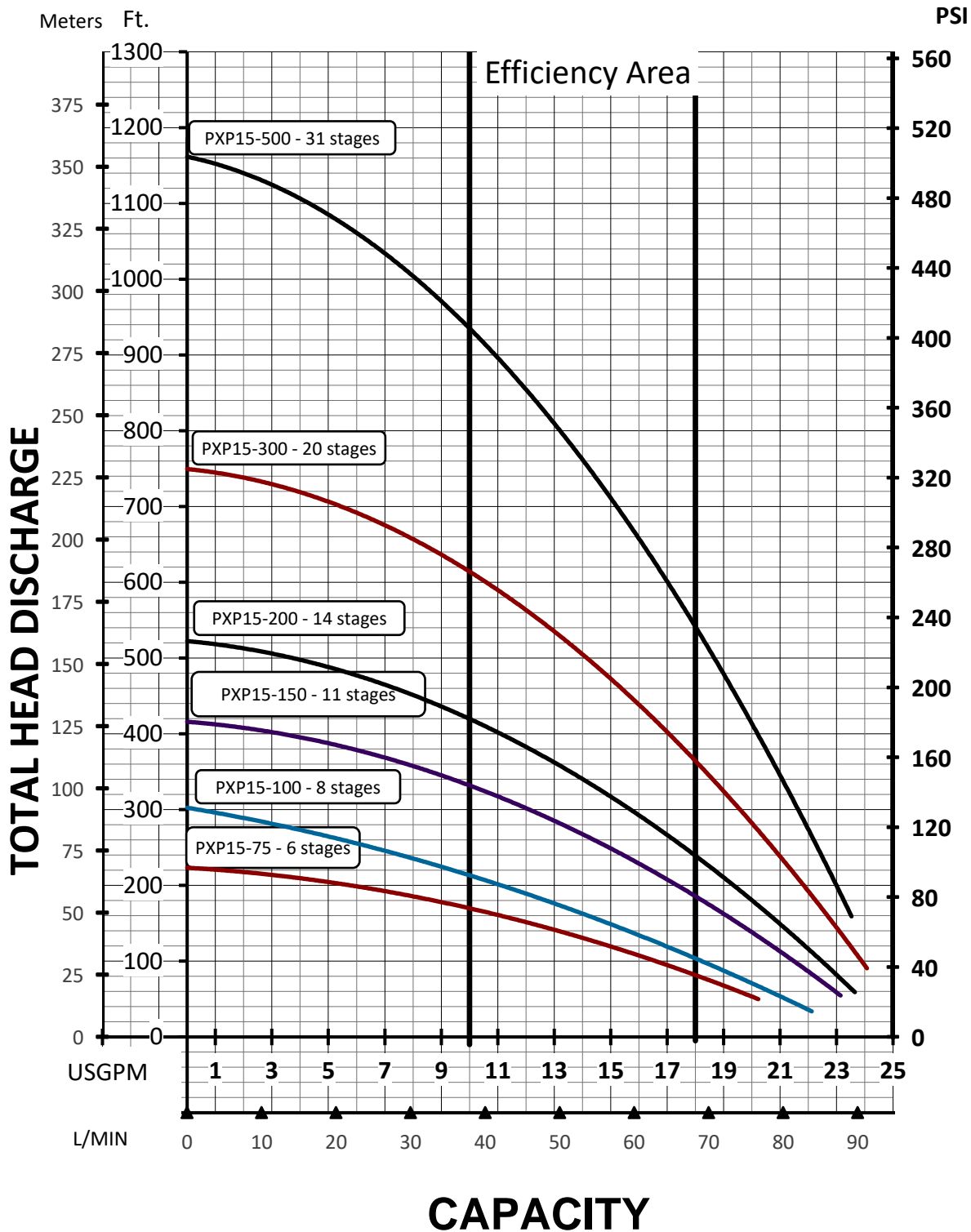

Pumping curves PXP



PXP 25 GPM

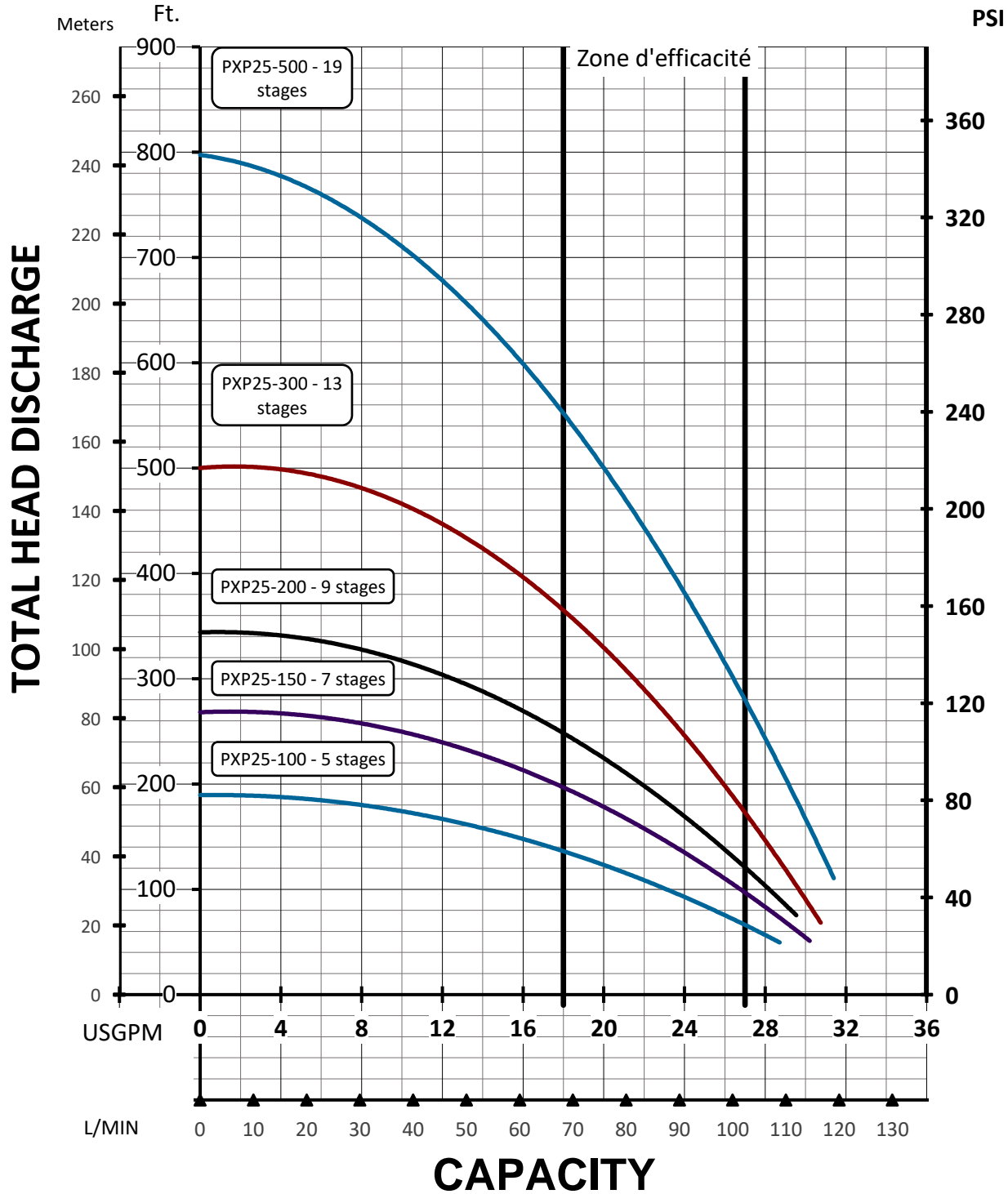



Pumping curves PXP

PXP 35 GPM

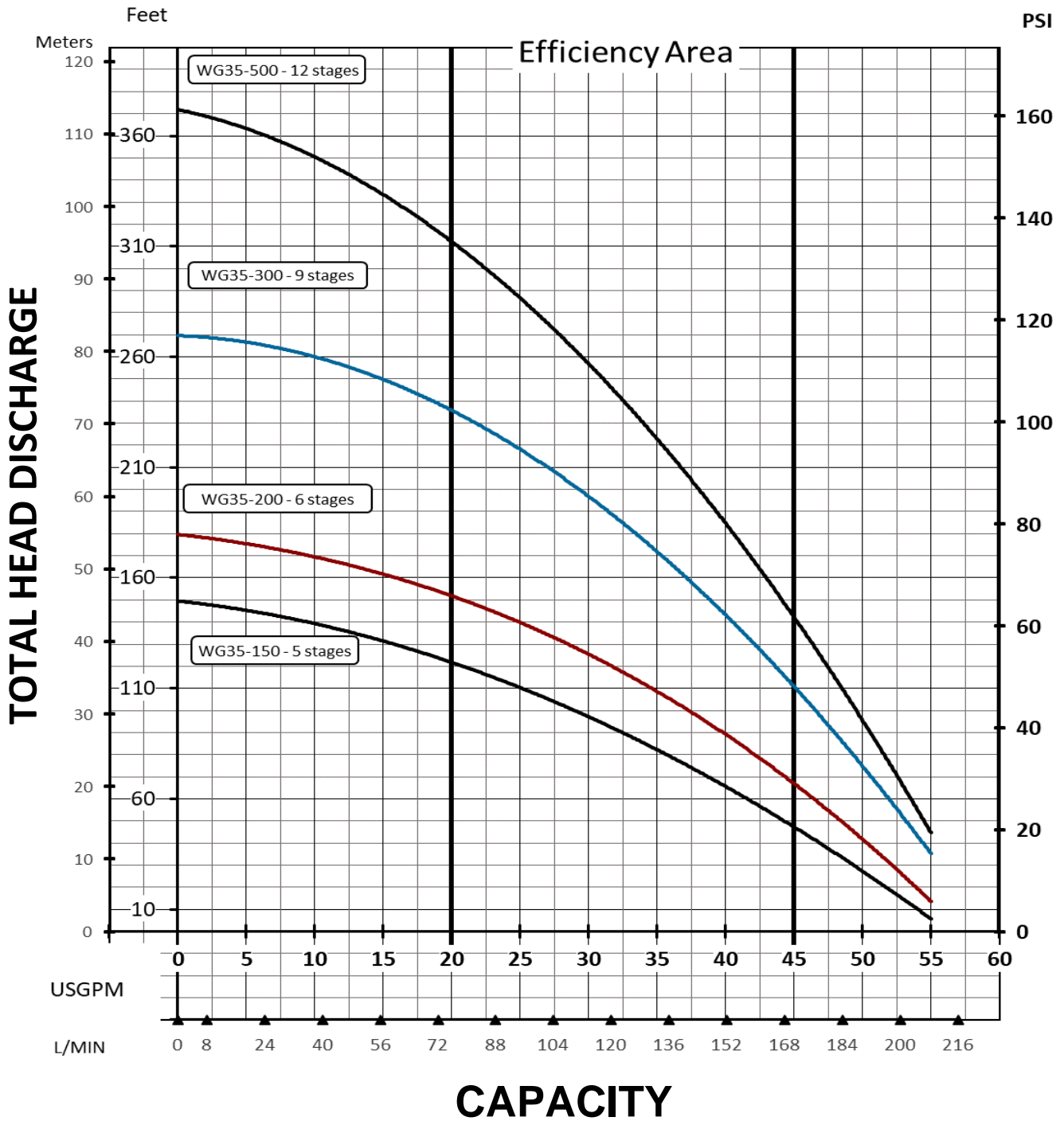

Pumping curves PXP



PXP 50 GPM

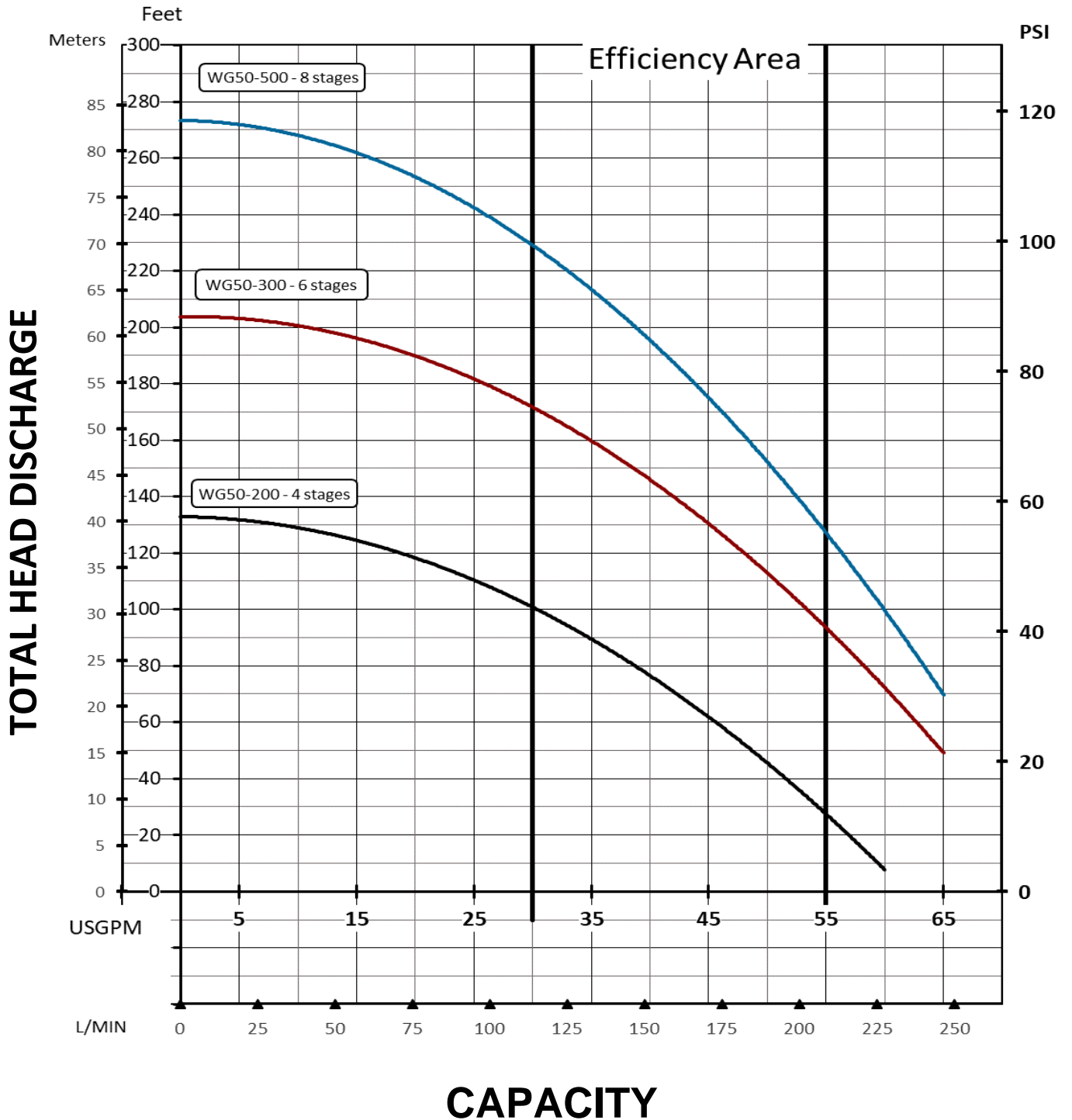

PXP 80 GPM

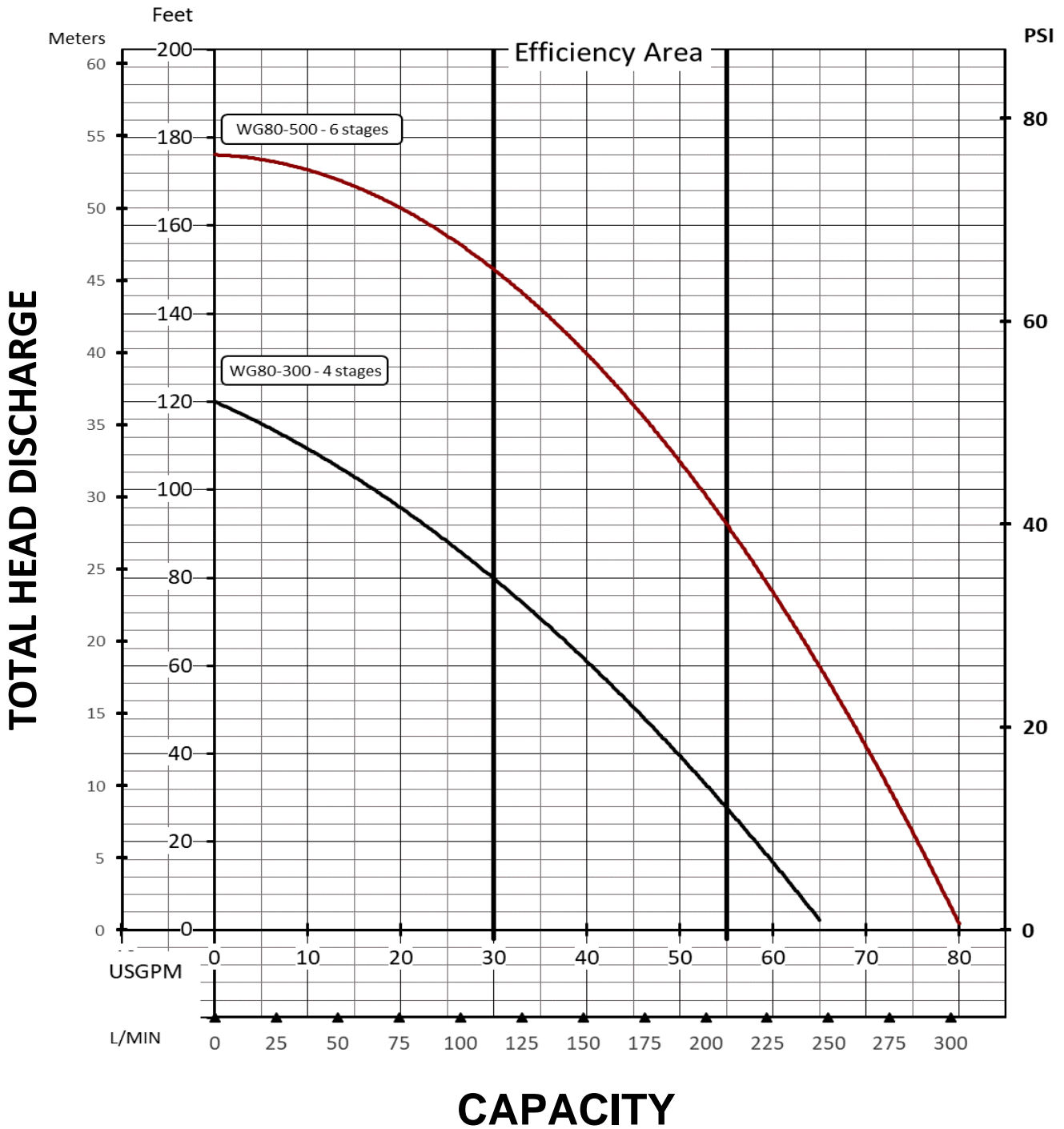

Replacement parts PXP

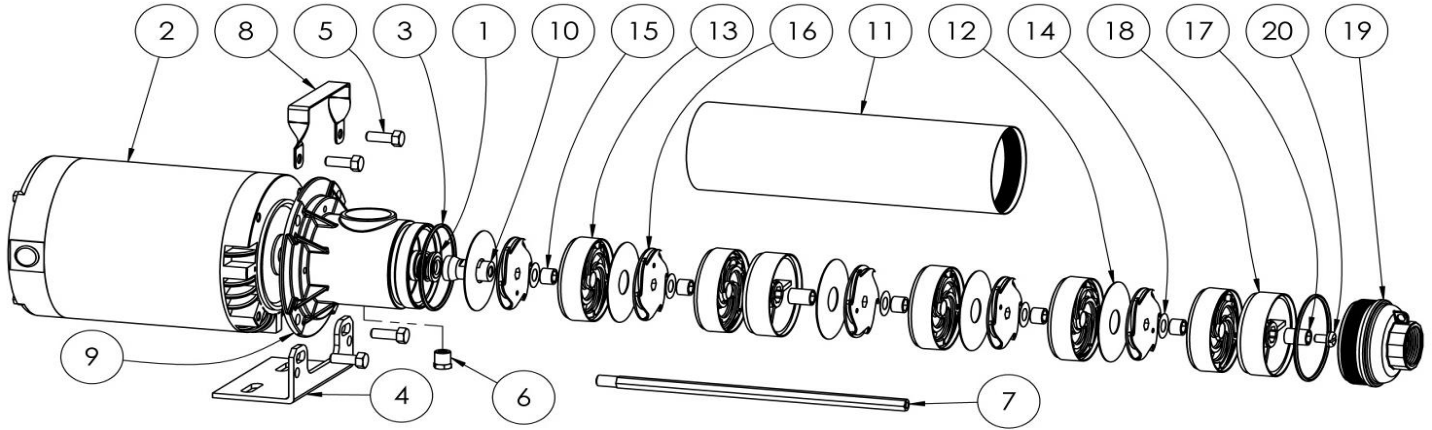

#	Part number	Description	6 G.P.M.				10 G.P.M.					15 G.P.M.					25 G.P.M.					Suggested list price			
			50	75	100	150	50	75	100	150	200	300	75	100	150	200	300	500	100	150	200		300	500	
1	124-0130	2000V model mechanical seal	1	1	1	1	1	1	1	1	1	1	1	1	1	1	1	1	1	1	1	1	1	1	20,20 \$
2	151-1210	1/2 H.P. motor 115/230 Volts	1				1																		416,00 \$
2	151-1230	3/4 H.P. motor 115/230 Volts		1				1																	474,00 \$
2	151-1250	1 H.P. motor 115/230 Volts			1				1						1								1		526,00 \$
2	151-1260	1 1/2 H.P. motor 115/230 Volts				1				1						1								1	631,00 \$
2	151-1280	2 H.P. motor 115/230 Volts									1													1	717,00 \$
2	151-1300	3 H.P. motor 230 Volts										1												1	1 145,00 \$
3	225-0045	#236 O'ring	2	2	2	2	2	2	2	2	2	2	2	2	2	2	2	2	2	2	2	2	2	2	1,40 \$
4	515-0090	Pump base	1	1	1	1	1	1	1	1	1	1	1	1	1	1	1	1	1	1	1	1	1	1	17,80 \$
5	569-0150	3/8-16 x 1" hexagonal bolt	4	4	4	4	4	4	4	4	4	4	4	4	4	4	4	4	4	4	4	4	4	4	1,30 \$
6	522-3510	1/4" NPT Hex. SS Plug.	1	1	1	1	1	1	1	1	1	1	1	1	1	1	1	1	1	1	1	1	1	1	4,40 \$
8	550-0010	Pump handle	1	1	1	1	1	1	1	1	1	1	1	1	1	1	1	1	1	1	1	1	1	1	18,00 \$
9	550-0055	Stainless Steel motor bracket	1	1	1	1	1	1	1	1	1	1	1	1	1	1	1	1	1	1	1	1	1	1	329,00 \$
10	550-0075	S/S Coupling	1	1	1	1	1	1	1	1	1	1	1	1	1	1	1	1	1	1	1	1	1	1	48,20 \$
12	554-0092	6-10-15-25 G.P.M S/S disc.	9	14	16	22	7	11	13	16	21	31	6	8	1	14	2	31	5	7	9	13	19	9,10 \$	
13	554-0100	6-10 G.P.M. diffuser	9	14	16	22	7	11	1	16	21	31													21,80 \$
13	554-0105	15-25 G.P.M. diffuser											6	8	11	14	20	31	5	7	9	13	19	20,10 \$	
14	554-0102	S/S washer	9	14	16	22	7	11	13	16	21	31	6	8	11	14	20	31	5	7	9	13	19	0,70 \$	
15	554-0103	Interstage Bushing S/S	9	14	16	22	7	11	13	16	21	31	6	8	11	14	20	31	5	7	9	13	19	6,20 \$	
16	554-0110	6 G.P.M. impeller	12	14	16	22																			14,40 \$
16	554-0115	10 G.P.M. impeller					7	11	13	16	21	31													14,40 \$
16	554-0120	15 G.P.M. impeller											6	8	11	14	20	31							14,40 \$
16	554-0125	25 G.P.M impeller																	5	7	9	13	19		14,40 \$
17	564-0005	Spacer Sleeve S/S	1	1	1	2	1	1	1	1	2	2	1	1	1	2	2	2	1	1	1	2	2	2	11,80 \$
18	564-0020	Spider bearing assembly	1	1	1	2	1	1	1	1	2	2	1	1	1	2	2	2	1	1	1	2	2	2	20,30 \$
19	564-0044	Stainless steel discharge head	1	1	1	1	1	1	1	1	1	1	1	1	1	1	1	1	1	1	1	1	1	1	89,50 \$
20	564-0055	Screw (upper shaft)	1	1	1	1	1	1	1	1	1	1	1	1	1	1	1	1	1	1	1	1	1	1	2,40 \$

NOTE: Please contact us for parts #7 & #11

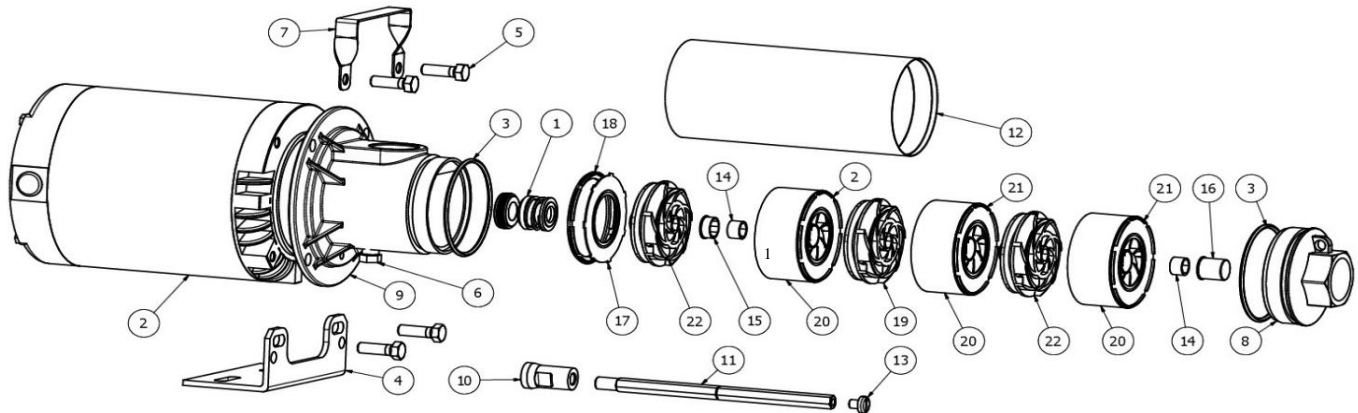

#	Part number	Description	35 G.P.M.				50 G.P.M.			80 G.P.M.		Suggested list price
			150	200	300	500	200	300	500	300	500	
1	124-0130	2000V model mechanical seal	1	1	1	1	1	1	1	1	20,20 \$	
2	151-1260	1 1/2 H.P. motor 115/230 Volts	1								631,00 \$	
2	151-1280	2 H.P. motor 115/230 Volts		1			1				717,00 \$	
2	151-1300	3 H.P. motor 230 Volts			1		1		1		1 145,00 \$	
2	151-1320	5 H.P. motor 230 Volts				1		1		1	2 115,00 \$	
3	225-0045	#236 o'ring	2	2	2	2	2	2	2	2	1,40 \$	
4	515-0090	Pump Base	1	1	1	1	1	1	1	0	17,80 \$	
5	519-0150	3/8-16 x 1" hexagonal bolt	4	4	4	4	4	4	4	4	1,30 \$	
6	522-3510	1/4" NPT hexagonal S/S plug	1	1	1	1	1	1	1	1	4,40 \$	
7	550-0010	Pump handle	1	1	1	1	1	1	1	1	18,00 \$	
8	550-0044	Stainless steel discharge head 1-1/4"	1	1	1	1	1	1	1	1	115,20 \$	
9	550-0056	Stainless steel motor bracket	1	1	1	1	1	1	1	1	403,80 \$	
10	550-0075	S/S coupling	1	1	1	1	1	1	1	1	48,20 \$	
13	564-0055	Screw (upper shaft)	1	1	1	1	1	1	1	1	2,40 \$	
14	569-1005	FP ceramic bearing	1	1	1	2	1	1	1	1	15,00 \$	
15	569-1006	4FP rubber bearing - inter				1					5,10 \$	
16	569-1010	4FP rubber bearing -top	1	1	1	1	1	1	1	1	5,10 \$	
17	569-1090	4FP S/S disc	1	1	1	1	1	1	1	1	7,60 \$	
18	569-1095	4FP disc ring	1	1	1	1	1	1	1	1	2,00 \$	
19	569-1115	4FP 35 G.P.M. intermediate impeller				1					22,20 \$	
20	569-1130	4FP 35-50 G.P.M. S/S diffuser tube	5	6	9	12	4	6	8		10,20 \$	
20	569-1135	4FP 80 G.P.M. S/S diffuser tube							4	6	11,00 \$	
21	569-1140	4FP 35-50 G.P.M. diffuser	5	6	9	12	4	6	8		16,00 \$	
21	569-1145	4FP 80 G.P.M. diffuser							4	6	19,60 \$	
22	569-1150	4FP 35 G.P.M. impeller	5	6	9	11					17,40 \$	
22	569-1155	4FP 50 G.P.M. impeller					4	6	8		15,60 \$	
22	569-1160	4FP 80 G.P.M. impeller							4	6	19,00 \$	

NOTE: Please contact us for parts #11 and #12